

RESHAPING THE WAY YOU DO BUSINESS

Portable Machining, Welding, and Advanced Valve Repair & Testing Systems

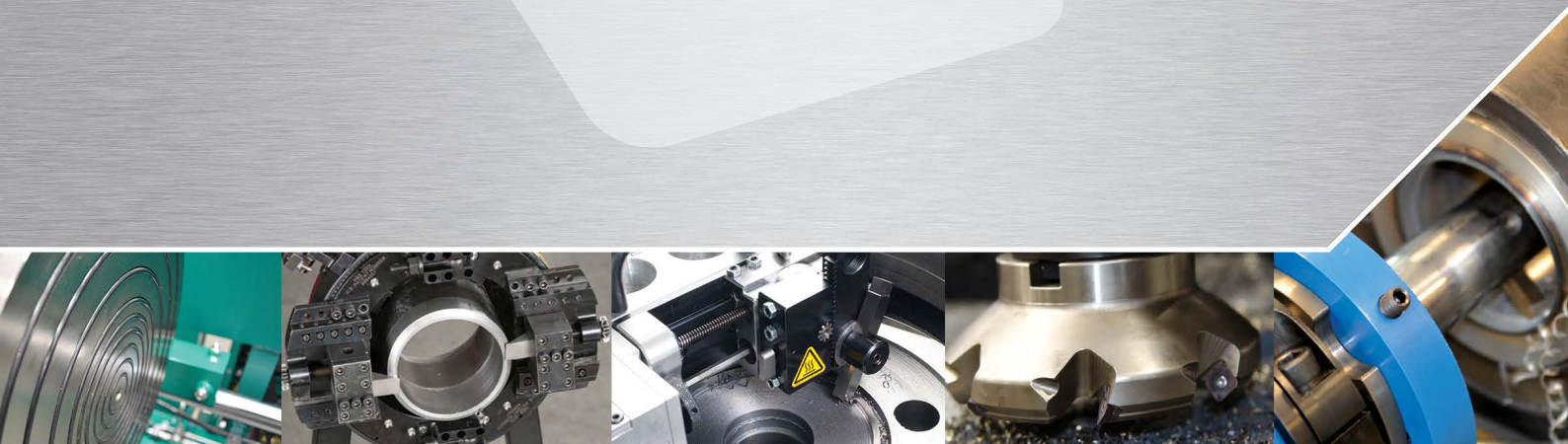

CLIMAX | BORTECH | CALDER | H&S TOOL
PRODUCTS AND SERVICES

For mission-critical machining, welding, or valve testing projects, CLIMAX is the world's premier choice for tools designed to reduce downtime and increase productivity



Why choose us?

CLIMAX pioneered the portable machining revolution in 1966. For more than 50 years we have been the innovators and technology leaders in the industry we invented. We're #1 for a reason! But we never rest – we're building on this legacy, expanding our businesses and looking forward to the next 50 years.

The powerful combination of CLIMAX, BORTECH, CALDER and H&S TOOL offers an unrivaled suite of equipment and end-to-end solutions. Customers trust CLIMAX for mission-critical manufacturing and repair work in a wide variety of industries including Oil & Gas, Mining & Heavy Construction, Power Generation, Ship Building & Repair, Aerospace & Defense, and many others. With CLIMAX sites and factory-certified representatives covering the globe, our team is committed to delivering an *outrageously* good customer experience – every interaction, every time, everywhere – 24/7!

CLIMAX is a pure-play equipment manufacturer. We don't perform on-site service work, making us the only global OEM in our industry that never competes with its customers for service business. CLIMAX is always the best value for the money, with more than 99% of our equipment proudly sourced and manufactured in the USA, where safety and quality standards are the highest in the world. Our products are manufactured in our ISO 9001 certified factory and meet international standards including CE certification.

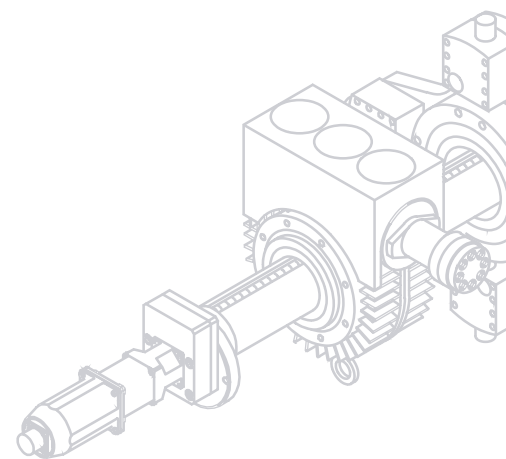

OUR MISSION

- ❧ Help our customers do their work better, faster, safer, and more cost-effectively by bringing the most innovative, highest-quality portable machining, welding, and testing tools right to the job.
- ❧ Deliver an outrageously good customer experience – every interaction, everywhere, every time!
- ❧ Have fun doing it!

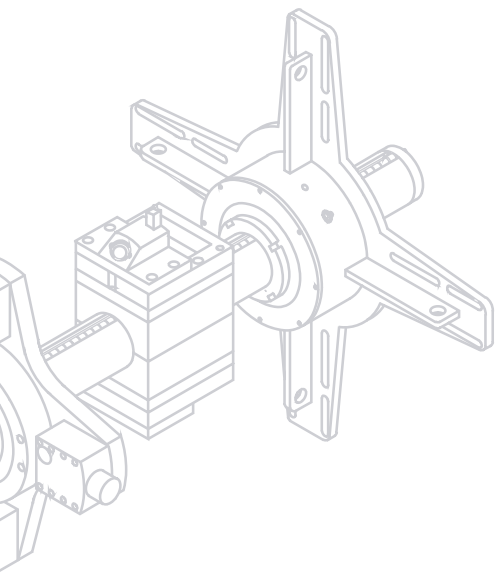

END-TO-END SOLUTIONS

Products, consulting, applications engineering, custom design, training, start-up and commissioning, after-sale service, spare parts, equipment repair and maintenance, and rentals - CLIMAX offers unmatched value in our industry!

Time-tested TOOLS that set the standard for productivity. Our 75-plus standard products, manufactured in the USA, are the best in their class for your on-site machining, welding and valve testing and repair needs, bringing the solution to the workpiece for enormous savings in time and money.

CUSTOM DESIGN capabilities to meet the most complex challenge. Our designers and engineers are second-to-none in applying advanced machining insights to the modification of existing products and accessories to meet special needs or customizing a completely unique solution to meet your “impossible” challenge head-on. Many of the patented innovations in today’s CLIMAX, BORTECH, CALDER, and H&S TOOL lineup originated from one of our engineers inventing a better way to help a customer optimize their productivity, safety, and results.

Grow your business with RENTAL equipment. When you need a machine tool for a one-time job, or for a test run prior to purchase, or to add capacity during busy periods, or even for backup on jobs where deadlines are critical, CLIMAX rental machines ensure you’ll receive the right tool for the job. With rental locations strategically located throughout the world, and the largest rental fleet in the industry, customers can quickly get the tools they need, when they need them.

OEM CERTIFIED TRAINING to keep your new and veteran workers on the cutting edge. There are no better machine tool or valve tester trainers than the people who have actually designed and built these systems for decades. Get hands-on training by our expert instructors, at one of our seven global training centers or at your own site anywhere in the world. Ask about our schedule of standardized training courses, or let us customize a training session to meet your particular needs.

Leading provider of TOOLING & BITS. Optimal performance is achieved with tooling and cutting bits that are specifically engineered for pairing with CLIMAX and H&S TOOL equipment. The carefully-selected materials and detailed geometry of our tooling provide the highest-quality results in the metal and the longest possible tool life. In many locations, we’ll deliver the tooling right to your door. We’ll even set up an auto-replenishment program customized to meet your exact needs in the most cost-effective manner.

REPAIR and MAINTENANCE SERVICES. Proper maintenance and repair of your equipment is crucial to its performance, safety, uptime, and longevity. Let our factory-certified technicians keep your equipment in top condition, so you can stay focused on your core business.

CONSULTATION, START-UP & TECH SUPPORT. Our applications engineers can help you figure out how to accomplish even the most complex or unusual machining jobs or valve testing work, in the safest, fastest and most cost-effective manner. We’re there to support you during all phases of your work: the up-front planning, training, start-up and commissioning, and troubleshooting and tech support throughout the process. Do your work with confidence, knowing that we have your back – start to finish!

LINE BORING MACHINES

CLIMAX boring machines support boring diameters from 1.5 to 80 inches (38.1 to 2030 mm) with the precision and speed of stationary machines. Specially designed mounting brackets, spherical bearings, self-centering setup cones and movable rotational drive and feed units simplify setup and allow the tools to work in spaces too tight for most boring machines. All models feature rugged rotational drive and axial feed systems, chrome plated precision bars and heavy duty bearings, with electric, pneumatic and hydraulic power options available. They can share the same mounting system with Auto Bore Welding Systems for single-setup machining and welding.



BB3000 Boring Machine

Optimal power-to-weight ratio assures superior speed and performance. Compact design and mounting brackets easily adapt to a wide range of configurations to maximize application versatility.



BB4500 Boring Machine

An even more compact and affordable version of our top-selling BB5000 technology, with the mounting flexibility needed for work in restrictive spaces. A variety of motor and bar options add power to this outstanding value.



BB5500 Boring Machine

Most suitable for turbine coupling applications. Easy to set up, designed to make quick work of tough jobs in spaces too restrictive for most boring machines. The extremely rigid system provides exceptional precision for accurate fitting of coupling bolts.

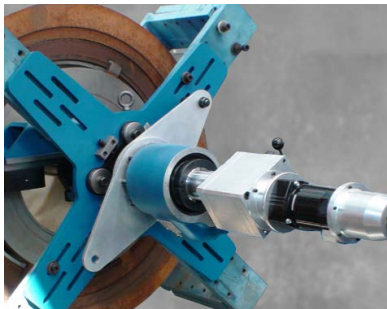

BB6100 Boring Machine

The most compact in our line of traveling head portable boring machines. Combines powerful performance with flexible setup to meet an exceptionally wide range of application and boring diameter needs.

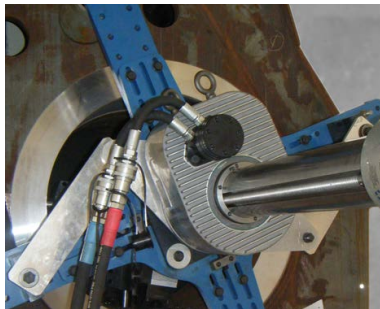

BB7100 Boring Machine

Designed to enable boring strokes limited only by the length of the bar. Includes plenty of power to tackle the big jobs.

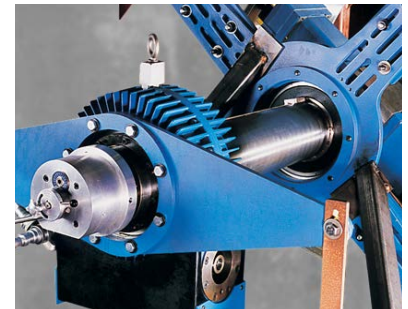

BB8100 Boring Machine

Designed to enable boring strokes limited only by the length of the bar and with plenty of power to tackle big jobs. Three different bearing support assemblies maximize versatility.

BORING MACHINES

LINE BORING MACHINES

APPLICATIONS Line boring of heavy construction equipment buckets and articulated joints • Drag line housing repair • Drilling of frozen studs or realignment of slew ring bolt holes • Heavy equipment and crusher gearbox repair • Line boring of dam wicket gate bushings • Ship stern tube and rudder leaf boring • Re-boring of turbine shell housings • Turbine coupling boring

BORING MACHINES



BB5000 Boring Machine

The most compact, versatile and powerful tool in its class. Easy to set up, designed to make quick work of tough jobs in spaces too restrictive for most boring machines. Easily configured for difficult machining applications.

PROJECT SUCCESS

BB5000 BORING MACHINE | NUCLEAR POWER PLANT

A customer had a 492 mm diameter flange around an oval man-way port in a nuclear reactor that needed to be machined to produce an oval flange 457 mm long and 355 mm wide. The material was mild steel with possible material property degradation, and the cover could not be used for mounting other than the inside edge of the port. A specially-modified CLIMAX BB5000 Boring Machine was used for this complex machining operation and provided an oval port with an oval flange, well within the targeted time.

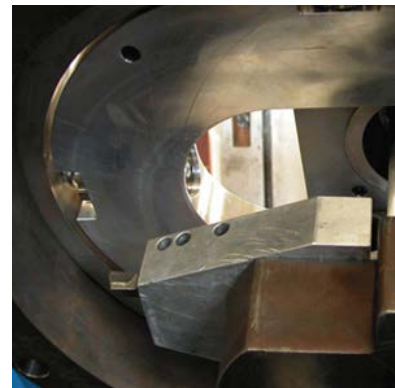

QUICK-TECH Boring Machine	BAR DIAMETER	BORING DIAMETER	MAX. STROKE	TORQUE@ BAR	POWER
BB3000	1.25 in. (31.8 mm)	1.5 - 5 in. (38.1 - 127 mm)	10 in. (254 mm)	40 ft-lb (54.2 N•m)	Electric
BB4500	1.75 in. or optional 1.25 in. (44.5 mm or optional 31.8 mm)	1.5 - 10 in. (38.1 - 254 mm)	36 in. (914.4 mm)	417 ft-lb (565.4 N•m)	Electric, pneumatic, or hydraulic
BB5000	2.25 in. or optional 1.25 & 1.75 in. (57.2 mm or optional 31.8 & 44.5 mm)	1.5 - 24 in. (38.1 - 609.6 mm)	36 in. (914.4 mm)	417 ft-lb (565.4 N•m)	Electric, pneumatic, hydraulic, or electric servo
BB5500	2.5 in. or optional 1.875 in. (63.5 mm or optional 47.6 mm)	2 - 4.2 in. (50.8 - 106.7 mm)	Length of bar	65 ft-lb (88.1 N•m)	Pneumatic or hydraulic
BB6100	3.5 in. (88.9 mm)	8.8 - 40.8 in. (223.5 - 1036.3 mm)	Length of bar	470 - 1820 ft-lb (637.2 - 2467 N•m)	Hydraulic
BB7100	5 in. (127 mm)	10.25 - 58.25 in. (260.4 - 1036.3 mm)	Length of bar	2230 ft-lb (3023.5 N•m)	Hydraulic
BB8100	8 in. (203.2 mm)	17.1 - 85.1 in. (434.3 - 2161.5 mm)	Length of bar	2692 ft-lb (3649.9 N•m)	Hydraulic

BORE WELDING MACHINES

The BORTECH **automated welding systems** are portable and can be used in both field and shop repairs. The automated welding systems are designed to attach directly to several CLIMAX boring machine mounting fixtures, allowing a single setup for both welding and machining operations, giving the operator the ability to weld one bore while machining another! These automated welders offer high-quality, affordable welding performance for bore, flange and valve repair.

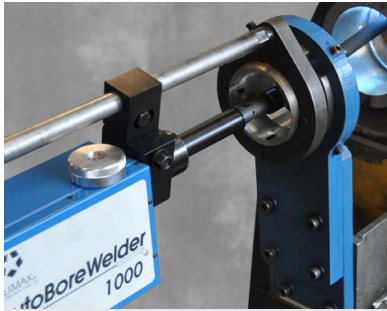

BW1000 Auto Bore Welder

The CLIMAX BW1000 Auto Bore Welder automated spiral welding system provides you with an affordable bore welding system. High quality bore welding technology is now available in a ruggedly constructed, highly portable and easily affordable package.

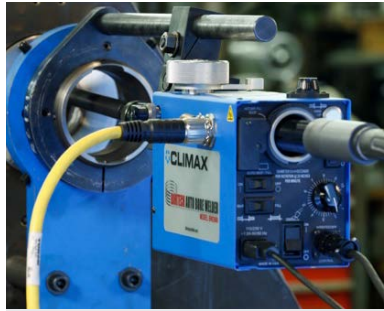

BW2600 Auto Bore Welder

The BW2600 Auto Bore Welder is a compact blend of simplicity, performance, and reliability, capable enough to tackle aggressive field applications with ease. The BW2600 interfaces directly with users existing MIG wire feed systems, providing skip / fill capability with burn back control for these functions, fully adjustable mechanical step, reversible weld direction, step lockout feature for face welding and optional remote pendant control.



BW3000 Auto Bore Welder

The BW3000 is the industry leader in auto bore welding and is the only bore welder that comes complete with a wire feeder and PLC control system, allowing all weld parameter adjustments from one central location. The BW3000 interfaces directly with the users MIG power supply, providing auto-skip, carriage return, and pie mode capability for easy repair of aggressively worn bores. Known for its performance and reliability, whether in-the-shop or in-the-field, the BW3000 produces precise, uniform, high-quality welds.

PRECISE, HIGH-QUALITY WELDS

BORTECH automated welding machines offer precise, high quality, uniform welding performance. Auto Bore Welders can produce a wide variety of welds, with less need for rework compared to hand welding. And with less wire being consumed, these machines reduce overall project costs while accelerating the user's return on investment.

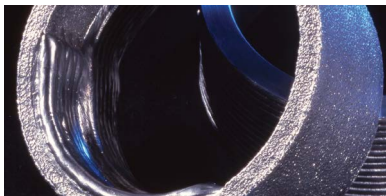

Bore welding full or partial weld



Small bore weld

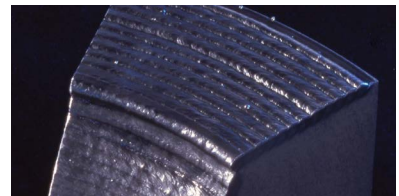

Conical seat weld

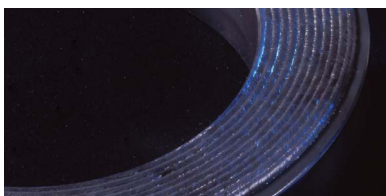

Face weld



Aluminum bronze bore weld

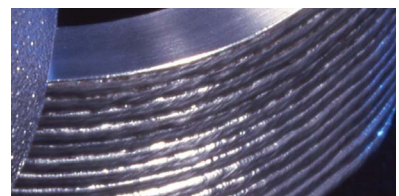

Outside diameter auto weld

WELDING MACHINES

climaxportable.com | hstool.com

BORE WELDING MACHINES

APPLICATIONS Valve and pump repair • Motor housings and shafts • Bores, pivot points, buckets and hitches • Shaft OD repair • Rotary crushers • Loader bucket & hitch repair • Gears and gear boxes • Compressors and turbines • Nozzles on pressure vessels and heat exchangers • Continuous miners and drag lines • Mud pumps • Rudder Bore • Hydraulic cylinder eye • Presses • Castings and injection molds • Jaw crusher pitman arms

WELDING MACHINES

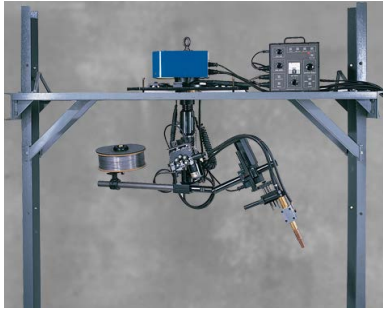

BW5000 Auto Bore Welder

A powerful welding and cladding system that rotates around the workpiece, the BW5000 Auto Bore Welder produces high-quality welding and cladding using any commercially available alloy such as Inconel™, Hastelloy™, Monel™, or stainless steel.

PROJECT SUCCESS

BW5000 AUTO BORE WELDER | ROCK CRUSHER

Our customer was presented with a challenge due to the irregular shape of a rock crusher head. The rock crusher was 7 ft (2.1 metres) in diameter and weighed 28,000 pounds (12.7 tonnes). With a CLIMAX BW5000 Auto Bore Welder, a jib crane and a little ingenuity, our customer was able to reduce the typical setup time from 20 hours to less than four hours. They were able to put on 900 pounds (0.45 tonnes) of wire, retaining consistent wire placement, without rotating the workpiece.



QUICK-TECH Welding Machine	AXIAL TRAVEL	WIRE DIAMETER RANGE	STEP RANGE AND PITCH	ROTATIONAL DIRECTION	AUTO-SKIP	STANDARD TORCH RANGE
BW1000	9 in. (228.6 mm)	0.030 - 0.045 in. (0.76 - 1.14 mm)	Pitch: 0.125 in. (3.2 mm) helical	Clockwise rotation	No	0.88 - 24 in. (22.4 - 609.6 mm)
BW2600	9 in. (228.6 mm)	0.030 - 0.045 in. (0.76 - 1.14 mm)	Step range: 0.050 - 0.200 in. (1.27 - 5.08 mm) per rev	Reversible	Skip & fill	0.88 - 24 in. (22.4 - 609.6 mm)
BW3000	6 or 12 in. (152.4 or 304.8 mm)	0.023 - 0.045 in. (0.58 - 1.14 mm)	Step range: 0.040 - 0.220 in. (1.0 - 5.6 mm)	Reversible	Auto skip, pie mode & carriage return	0.50 - 54 in. (12.7 - 1371.6 mm)
BW5000	10, 20, 30, 40 & 50 in. (254, 508, 762, 1016 & 1270 mm)	0.045 - 0.062 in. (1.1 - 1.6 mm)	Step range: 0.070 - 0.325 in. (1.78 - 8.26 mm)	Reversible	Auto skip, pie mode & carriage return	12 - 120 in. (304.8 - 3048.0 mm)

FLANGE FACERS, SMALL ID MOUNT

With various models to reface, mill, bevel, square, counterbore, or cut end prep configurations for welding, CLIMAX and H&S TOOL offer a wide variety of rugged and innovative portable **flange facers** for 0.75 to 19 inch (19.1 to 482.6 mm) diameters, for ID mounting. For easy setup, the smaller units use an integral mandrel to quickly lock into place.

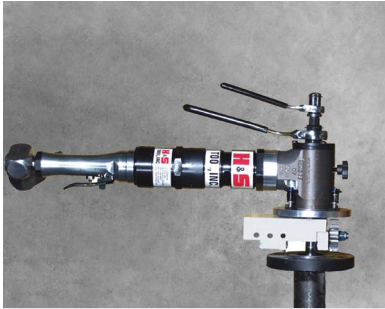

MODEL BF Flange Facer

Simple, safe, and accurate. The model BF is a versatile flange facer designed for flanges ranging from 0.75 inch ID to 4.12 inches OD (19.1 to 104.6 mm).

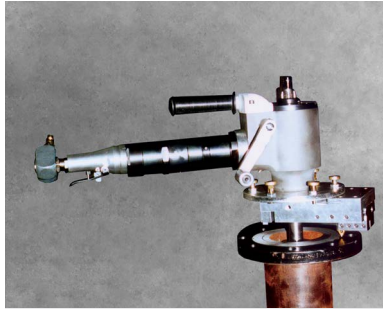

MODEL MSF Flange Facer

The model MSF resurfaces flanges from 1.25 inches ID to 6.19 inches OD (31.8 to 157.2 mm) quickly and accurately. Works with our BG50 BOILER GUN™ for quick and easy conversion between beveling and flange facing in the field.

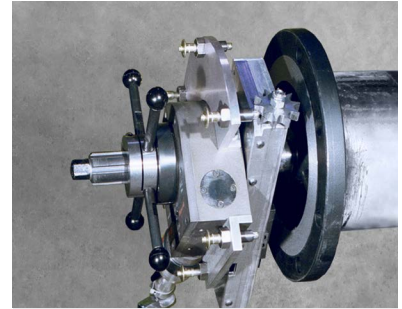

MODEL MTF Flange Facer

The model MTF resurfaces flanges ranging from 3.25 inches ID to 10.63 inches OD (82.6 to 270.0 mm) quickly and accurately. Works with our PB8 POWER BEVELER for quick and easy conversion between beveling and flange facing in the field.



FF3000 Flange Facer

One of the most compact and versatile tools of its kind. With its modular design, tool-less set up and a bi-directional, infinitely variable feed, it faces and bevels with remarkable speed and precision. Facing diameters range from 1.5 to 12 inches (38.1 to 304.8 mm).

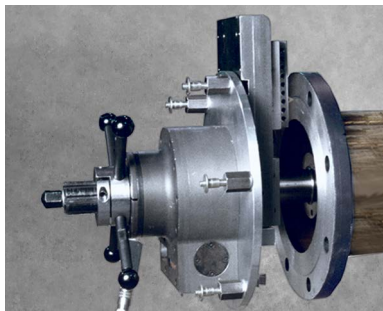

MODEL MFTF Flange Facer

Job-tested and field proven, the model MFTF will accurately resurface raised gasket areas and bolt pattern surfaces from 4.25 inches ID to 16.25 inches OD (108.8 to 412.8 mm).



FF4000 Flange Facer

Designed for machining mid-sized diameter raised face and flat pipe flanges or beveling pipe with optional beveling head. Sets up in less than 10 minutes and delivers enough power to remove one cubic inch of metal per minute. Facing diameters range from 3 to 19 inches (76.2 to 482.6 mm).

FLANGE FACERS

FLANGE FACERS, SMALL ID MOUNT

APPLICATIONS Re-facing of main steam inlet flanges • Heat exchanger nozzle flange repair • Facing and beveling of pipe for sealing and weld prep • Repair of flat face, raised face and phonographic finish flanges • Repair piston rod mating flanges • Boiler feed pump flanges • Re-machining gasket seal on tube sheet • Repairing ring grooves or cutting new grooves • Plate and vessel weld prep

PROJECT SUCCESS

FF4000/FF5000 FLANGE FACER | GAS POWER PLANT

The Hillabee Energy Center, a dormant gas-powered plant in Alabama, USA, needed help in reviving the plant to get it back online and ready for purchase by a major utility company. They rented two CLIMAX flange facers, the FF4000 and FF5000, to repair corroded flanges and other piping components. Using the FF4000 and FF5000, 15 machinists were able to machine approximately 8 to 10 flanges per day, which resulted in increased productivity and helped them complete the project ahead of schedule. Not only that, but all flanges machined met the utility's stringent spec requirements.



QUICK-TECH Flange Facer	FACING DIAMETER	ID MOUNTING DIAMETER	FEED RATE	POWER
MODEL BF	0.75 in. ID - 4.12 in. OD (19.1 - 104.6 mm)	0.625 - 2.875 in. (15.9 - 73 mm)	0.005 in. (0.13 mm) per pin	Pneumatic or electric
MODEL MSF	1.25 in. ID - 6.19 in. OD (31.8 - 157.2 mm)	1 - 5 in. (25.4 - 127 mm)	0.005 in. (0.13 mm) per pin	Pneumatic or electric
MODEL MTF	3.25 in. ID - 10.63 in. OD (82.6 - 270 mm)	2 - 8.5 in. (50.8 - 215.9 mm)	0.005 in. (0.13 mm) per pin	Pneumatic or electric
FF3000	1.5 - 12 in. (38.1 - 304.8 mm)	1.5 - 6.75 in. (38.1 - 171.5 mm)	0 - 0.025 in./rev (0 - 0.635 mm/rev)	Pneumatic
MODEL MFTF	4.25 in. ID - 16.25 in. OD (19.1 - 412.8 mm)	3 - 13.5 in. (76.2 - 343 mm)	0.005 in. (0.13 mm) per pin	Pneumatic or electric
FF4000	3 - 19 in. (76.2 - 482.6 mm)	3 - 12.5 in. (76.2 - 317.5 mm)	0 - 0.025 in./rev (0 - 0.635 mm/rev)	Pneumatic

FLANGE FACERS, LARGE ID MOUNT / CIRCULAR MILL

CLIMAX offers a wide variety of rugged and innovative portable **flange facers** for 5 to 120 inches (127 to 3048 mm), for ID, OD or Surface Mounting. The ability to reface, mill, bevel, square, counterbore or machine weld prep or seal ring profiles, as well as the ability of many to convert from single point to milling operations, make these machines extremely versatile.

The CLIMAX **circular mill**, with a milling range of 73.5 to 199 inches (1867 to 5054 mm), delivers fast, versatile and accurate machining to meet the demanding wind tower or large crane base machining applications. Servo control, optional single point turning and ID, OD or surface mounts provide a truly versatile machine.

FLANGE FACERS

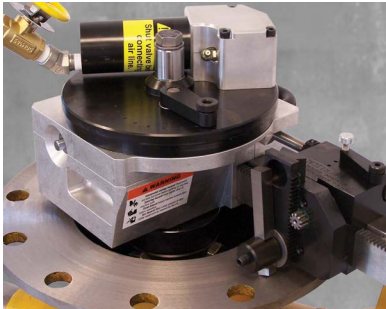

FF5000 Flange Facer

A two-piece mounting system makes this low profile unit easy to set up and align. Lightweight and simple to use whether you're facing, beveling or turning valve, pipe or pump flanges. Facing diameters range from 5 to 24 inches (127 to 609.6 mm).



FF5300 Flange Facer

Easy to set-up and run with a new modular design including an interchangeable turning arm, giving users the flexibility to go out to 40 inches (1,016 mm) and still produce the desired finish. Powerful and simple to use whether you're facing, beveling or turning valve, pipe, or pump flanges. Comes with a more compact swing diameter with a minimum clearance of 22.75 inches (577.9 mm). Facing diameters range from 5.7 to 40 inches (144.8 to 1016 mm).

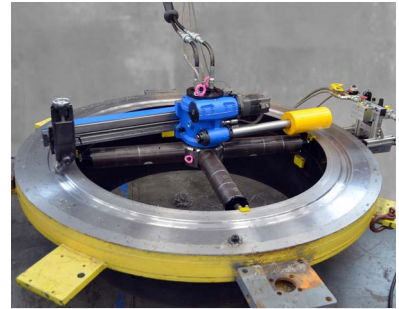

FF6300 Flange Facer

Performance, versatility, and safety. Delivers high-torque performance to quickly re-surface flanges and repair sealing and bearing surfaces efficiently and cost-effectively. Can be configured in either ID, OD, or surface-mount configurations for a variety of machining applications, with a quick and easy changeover. Facing diameters range from 11.8 to 60 inches (299.7 to 1524.0 mm).

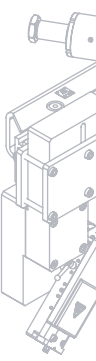

CIRCULAR MILL

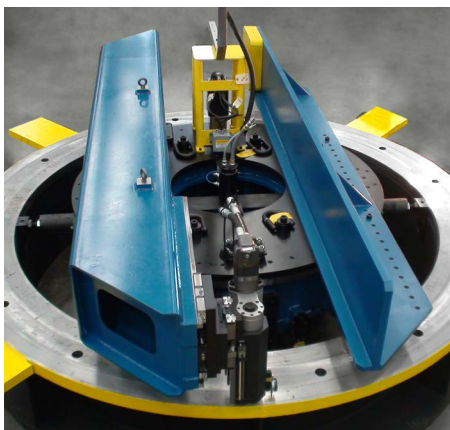

CM6200 Circular Mill

For machining large flanges 73.5 to 199 inches (1866.9 to 5054.6 mm) in diameter, and featuring a center machine clearance designed to fit over 24 inch (609.6 mm) diameter kingpins, this Circular Mill can be configured for powerful milling, single-point machining, and grinding operations. Extraordinary rigidity, versatility, and power are at your fingertips – this machine can handle your toughest large flange machining jobs quickly and efficiently.

FLANGE FACERS, LARGE ID MOUNT / CIRCULAR MILL

APPLICATIONS Re-facing of ship hatch sealing surfaces • Re-machining of rotary crane bearing surfaces • Re-facing of main steam inlet flanges • Re-surfacing of large pump base housings • Re-facing of valve flanges • Heat exchanger repair • Wind tower section flange milling • Ship thruster mount facing, milling and drilling

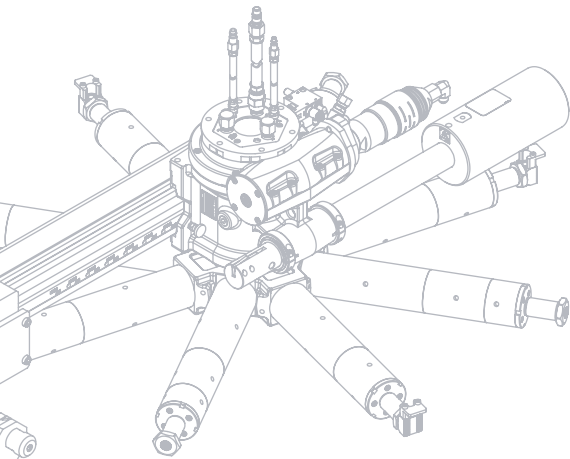

FLANGE FACERS

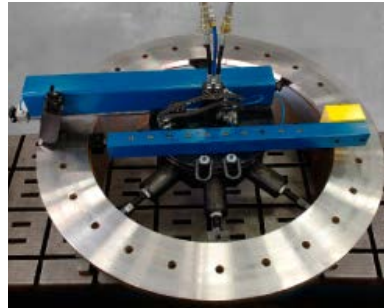

FF7200 Flange Facer

A heavy-duty flange facer with both facing AND milling capabilities. Features a tool head that rotates a full 360 degrees, infinitely variable feed rates, and remotely adjustable feed so radial and axial feeds can be done quickly and safely. Facing diameters from 30 to 72 inches (762 to 1828.8 mm), milling diameters from 35 to 72 inches (889 to 1828.8 mm).



FF8200 Flange Facer

A true workhorse, with the size and muscle to machine large-diameter flange faces. It gives up nothing in accuracy thanks to its rigidity, easy positioning, and uniform rotation rates, even when mounted in vertical flanges. Features a tool head that can be rotated a full 360°, infinitely variable feed rates, and remotely adjustable air-powered feedbox so radial and axial feeds can be done quickly and safely. Facing AND milling diameters range from 45 to 120 inches (1143 to 3048 mm).

QUICK-TECH Flange Facer	FACING DIAMETER	MILLING DIAMETER (ID MOUNT)	ID MOUNTING DIAMETER	OD MOUNTING DIAMETER	MINIMUM SWING DIAMETER	POWER
FF5000	5 - 24 in. (127 - 609.6 mm)	Single point only	5 - 18 in. (88.9 - 457.2 mm)	ID mount only	19 in. (482.6 mm)	Pneumatic
FF5300	5.7 - 32 in. (144.8 - 812.8 mm)	Single point only	5.7 - 32 in. (144.8 - 812.8 mm)	ID mount only	22.75 in. (577.9 mm)	Pneumatic
FF5300 with Extended Arm	5.7 - 40 in. (144.8 - 1016 mm)	Single point only	5.7 - 32 in. (144.8 - 812.8 mm)	ID mount only	26.25 in. (666.8 mm)	Pneumatic
FF6300*	11.8 - 60 in. (299.7 - 1524.0 mm)	Single point only	11.8 - 57.5 in. (299.7 - 1460.5 mm)	38.1 - 63.8 in. (967.7 - 1620.5 mm)	39.4 in. (1000.8 mm)	Pneumatic
FF7200*	30 - 72 in. (762 - 1828.8 mm)	35 - 72 in. (889 - 1828.8 mm)	30 - 72 in. (762 - 1828.8 mm)	ID mount only	55.8 in. (1417.3 mm)	Pneumatic or hydraulic
FF8200*	45 - 120 in. (1143 - 3048 mm)	45 - 120 in. (1143 - 3048 mm)	45 - 120 in. (1143 - 3048 mm)	89.8 - 136.4 in. (2280.9 - 3464.6 mm)	84.7 in. (2151.4 mm)	Pneumatic or hydraulic
QUICK-TECH Circular Mill	FACING DIAMETER	MILLING DIAMETER (ID MOUNT)	ID MOUNTING DIAMETER	OD MOUNTING DIAMETER		POWER
CM6200*	69.5 - 189 in. (1765.3 - 4800.6 mm)	73.5 - 199 in. (1866.9 - 5054.6 mm)	78.9 - 177.2 in. (2004.1 - 4500.9 mm)	98.4 - 209.9 in. (2499.4 - 5331.5 mm)	135.6 in. (3444.2 mm)	Electric servo

*Surface mount available

FLANGE FACERS, OD MOUNT

With various models of **OD mount flange facers** to reface, mill, bevel, square, counterbore, or cut end prep configurations for welding, CLIMAX offers a wide variety of rugged and innovative portable flange facers, for 0 to 120 inch (25 to 3050 mm) diameters, for OD mounting, and several of our machines can be configured for facing, milling, or both! For easy setup, larger units can be installed with a separate mount or chuck to which the facer body is installed.

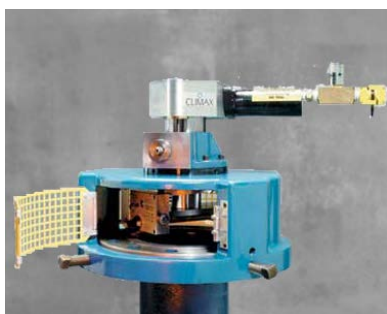

FF1000 Flange Facer

This OD-mount machine features a low-profile power module and centering/leveling plate for fast and easy setup. Mounting bell with wide-access windows simplifies gearbox adjustments. Facing diameters range from 0 to 12 inches (0 to 304.8 mm).



FF1200 OD Mount Flange Facer

This safe, versatile, and rugged OD Mount Flange Facer can machine flanges up to 12.5 inches (317.5 mm) in diameter without any attachments. Designed for the rugged challenges of the oil, gas and chemical industry, this machine has the versatility to machine seven different flange types, including RTJ and compact flanges. With feed controls located remotely for "hands-free machining," the FF1200 sets a new standard in operator safety while delivering up to 30% time savings on flange facing jobs.



FF2400 OD Mount Flange Facer

Delivering superior performance and safety, this OD Mount Flange Facer can machine flanges up to 24.5 inches (622.3 mm) in diameter without any attachments. Designed to perform in the harshest of environments, this machine can handle flat face, raised face, RTJ, tongue and groove, lens ring, Grayloc®, and compact flanges. Like the other CLIMAX OD Mount Flange Facers, this machine delivers world-class operator safety with remote feed controls and a low-pressure safety interlock system that prevents unintended re-starts if air pressure is interrupted.



FF3600 OD Mount Flange Facer

Unrivaled in capability for its size, this robust OD Mount Flange Facer can machine flanges up to 36.5 inches (927.1 mm) in diameter without any attachments. Like the other CLIMAX OD Mount Flange Facers, this machine comes standard with infinitely variable feed rates that can be adjusted while the machine is running, maximizing the user's ability to perform even in the most challenging environments within the oil and gas, power generation, and shipbuilding & repair industries.

ID or OD MOUNT CONFIGURATIONS

OD mount configurations are also available for larger CLIMAX ID mount flange facers.



FF6300 Flange Facer

OD Mounting Diameters:
38.1 - 63.8 in. (967.7 - 1620.5 mm)

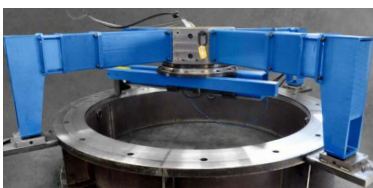

FF8200 Flange Facer

OD Mounting Diameters:
89.8 - 136.4 in. (2280.9 - 3464.6 mm)

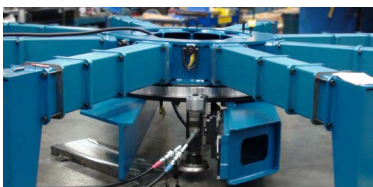

CM6200 Circular Mill

OD Mounting Diameters:
98.4 - 209.9 in. (2499.36 - 5331.46 mm)

FLANGE FACERS

climaxportable.com | hstool.com

FLANGE FACERS, OD MOUNT

APPLICATIONS Re-facing of ship hatch sealing surfaces • Re-machining of rotary crane bearing surfaces • Re-facing of main steam inlet flanges • Re-surfacing of large pump base housings • Re-facing of valve flanges • Heat exchanger repair • Re-facing compact flange face angles and RTJ grooves • Wind tower section flange milling • Ship thruster mount facing, milling and drilling • Pipeline flange re-facing

SPEED FACER™



ODF 30 - 70 SPEED FACER™

The H&S TOOL SPEED FACER™ family are designed with safety and productivity-enhancing features that separate this line of machines from the competition. The remote feed control and auto-feed system allows for hands-free machining, keeping operators hands away from moving parts. The customized setup fingers and leveling feet allow the operator to easily set up the machine making it possible to go from crate-to-cut in 15 minutes or less. With infinitely variable feed rates and the ability to rotate the tool head and bits 360°, the SPEED FACER™ family has increased flexibility for higher metal removal, variable surface finishes, and the ability to create a variety of cuts.

THE SPEED FACER™ FAMILY

We can build any SPEED FACER™ up to 120 inches (3048 mm) in diameter on request.



QUICK-TECH Flange Facer	FACING DIAMETER	FEED RATE	OD MOUNTING DIAMETER	POWER
FF1000	0 - 12 in. (0 - 304.8 mm)	0 - 0.035 in./rev (0 - 0.889 mm/rev)	2 - 12 in. (50.8 - 304.8 mm)	Pneumatic
FF1200	0 - 12.5 in. (0 - 317.5 mm)	0 - 0.035 in./rev (0 - 0.889 mm/rev)	2 - 14 in. (50.8 - 355.6 mm)	Pneumatic
FF2400	0 - 24.5 in. (0 - 622.3 mm)	0 - 0.035 in./rev (0 - 0.889 mm/rev)	8 - 26 in. (203.2 - 660.4mm)	Pneumatic
FF3600	0 - 36.5 in. (0 - 927.1 mm)	0 - 0.035 in./rev (0 - 0.889 mm/rev)	20 - 38 in. (508 - 965.2 mm)	Pneumatic
ODF30	0 - 30.5 in. (0 - 774.7 mm)	0.001 - 0.032 in./rev (0.025 - 0.813 mm/rev)	9.2 - 30.5 in. (233.7 - 1790.7 mm)	Pneumatic
ODF40	0 - 40.5 in. (0 - 1028.7 mm)	0.001 - 0.032 in./rev (0.025 - 0.813 mm/rev)	19.2 - 40.5 in. (487.7 - 1028.7 mm)	Pneumatic
ODF50	0 - 50.5 in. (0 - 1282.7 mm)	0.001 - 0.032 in./rev (0.025 - 0.813 mm/rev)	29.2 - 50.5 in. (741.7 - 1282.7 mm)	Pneumatic
ODF60	0 - 60.5 in. (0 - 1536.7 mm)	0.001 - 0.032 in./rev (0.025 - 0.813 mm/rev)	39.2 - 60.5 in. (995.7 - 1536.7 mm)	Pneumatic
ODF70	0 - 70.5 in. (0 - 1790.7 mm)	0.001 - 0.032 in./rev (0.025 - 0.813 mm/rev)	49.2 - 70.5 in. (1249.7 - 1790.7 mm)	Pneumatic

LATHES / DRILLS

Whether cutting O-ring grooves, repairing turbine spindles, or fixing an out-of-round gear seat area on the shaft of a high-speed production machine, a CLIMAX **portable lathe** can pay for itself on its first job. Our family of lathes bolt onto the end of a shaft to re-turn shafts and roll journals from 1.5 inches to 24 inches (38 to 610 mm). Some models can work in quarters as tight as 7 inches (177.8 mm) of radial clearance, while the PL4000 has the ability to machine a tapered shaft. Pneumatic power is standard, with optional electric power available on several models.

Our **portable drill** is engineered to deliver high-torque performance to quickly drill more holes in less time!

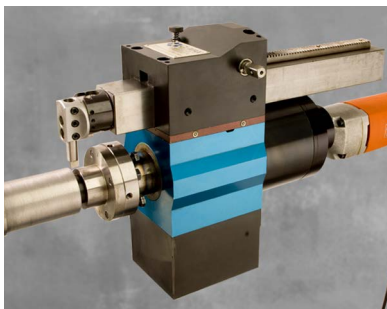

PL2000 Lathe

Plenty of power in a compact package. Gets the job done with just 7 inches (177.8 mm) of radial clearance. Its simplified mounting, bolted directly to the end of the shaft, speeds setup and reduces costly downtime for work on shaft diameters from 1.5 to 9 inches (38.1 to 228.6 mm).

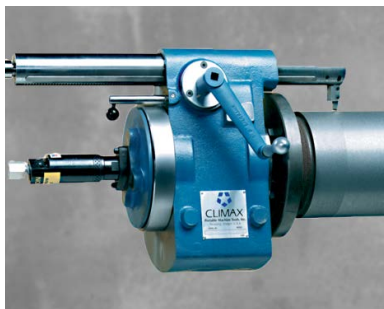

PL3000 Lathe

Re-turns large shafts and roll journals by mounting directly to the work piece and rotating around the shaft. Ruggedly dependable, accurate and powerful, it can eliminate hours of equipment dismantling. Designed for shaft diameters from 4 to 11.25 inches (101.6 to 285.8 mm).

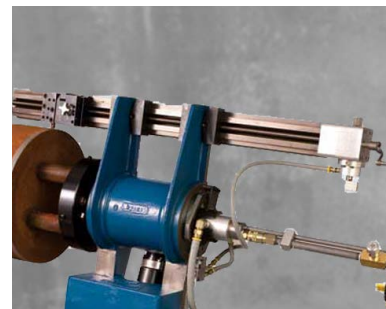

PL4000 Lathe

Does big jobs in tight spots. Mounts to the end of the workpiece, requires minimal clearance, and re-turns both straight and tapered shafts precisely. Its turning bar is easily adjusted for reach, turning radius and obstacle clearance on projects with shaft diameters ranging from 8 to 24 inches (203.2 to 609.6 mm).

LATHES

PROJECT SUCCESS

PL4000 LATHE | RIBBON BLENDER FOR ASPHALT

A customer was asked to repair a ribbon blender used for mixing asphalt. The bearings seized and caused big grooves in the shaft which had to be welded up and then machined to size. The shaft was about 9 inches (228.6 mm) in diameter and the bearing fit was around 25 inches (635 mm) from the end of the shaft. They also had an obstruction at the opposite end of the blender that was creating a limited swing clearance. With a PL4000 they were able to machine the grooves in the shaft to size and clear the obstruction.

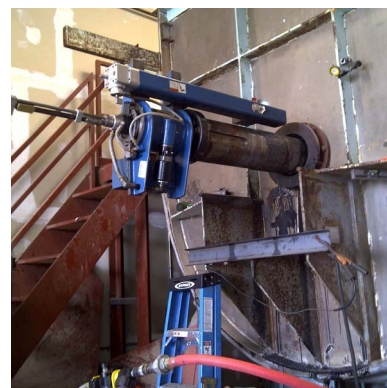

LATHES / DRILLS

LATHE APPLICATIONS Repairing of yoke assemblies on ship rudder control devices • Re-machining of rotor journal turbine shafts and fan shafts • Re-turning of elevator motor shafts • Re-machining of agitator journals • Re-machining of gearing journals on large shafts

DRILL APPLICATIONS Drilling holes in catapult troughs on aircraft carriers • Drilling holes in Titanium • Drilling bolt patterns for vertical magnetic plates • Ream out holes • Stud removal • Repair bolt holes and threads on shaft coupling flanges • Over-sizing holes on flanges for clearance • Repairing bolt holes on bodies and frames, drilling and tapping inside SAG mill

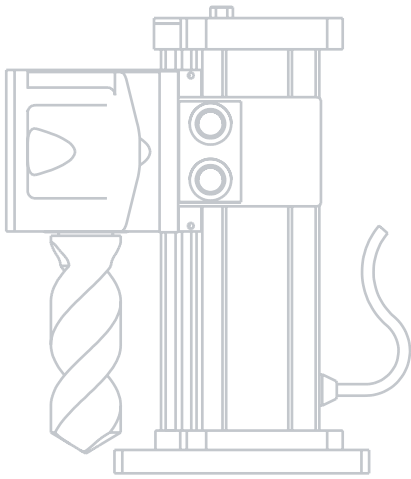

DRILLS

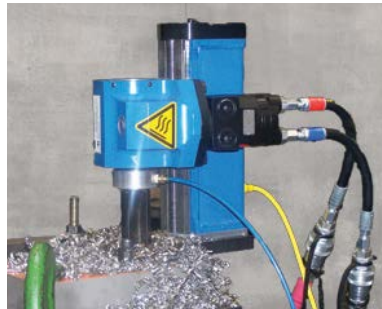

Compact Drills

Our family of customizable Compact Drilling Machines is ideal for machining applications which call for drilling holes up to 2.5 inches (63.5 mm) in a single pass, step drilling or roto-broaching up to 4.5 inches (114.3 mm) and back-spot facing up to 5.2 inches (132.1 mm). This machine meets tight side clearances which require holes to be within 2.5 inches (63.5 mm) of an obstruction with overhead clearances as low as 15 inches (381 mm).



PD3000 Pneumatic Drill

The PD3000 Pneumatic portable drill delivers high-torque performance to quickly drill more holes in less time! Our drill is equipped with a 3.0 HP motor and can reliably drill holes up to 1.5 inches (38.1 mm) in diameter through tough metals like HY80 steel.

QUICK-TECH Lathe	MAXIMUM TURNING REACH	SHAFT DIAMETER	CUTTER	POWER	
PL2000	12.5 in. (317.5 mm)	1.5 - 9 in. (38.1 - 228.6 mm)	1/2 in. (12.7 mm) HSS round lathe tool bit	Electric or pneumatic	
PL3000	22 in. (558.8 mm)	4 - 11.25 in. (101.6 - 285.8 mm)	3/8 in. (10 mm) lathe tool bit	Electric or pneumatic	
PL4000	27 in. (685.8 mm)	8 - 24 in. (203.2 - 609.6 mm)	1/2 in. (12.7 mm) square lathe tool bit	Pneumatic	
QUICK-TECH Drill	FEED RATE	MAXIMUM CUTTING DEPTH	SPINDLE SIZE	DRILL SIZE	POWER
PD3000	0.003 or 0.006 ipr (0.076 or .152 mm/rev)	6.5 in. (165.1 mm)	Morse taper #3	0.69 - 1.5 in. (1.75 - 38.1 mm)	Pneumatic (3 HP)
Compact Drill Family	0.3 - 2.5 in./minute (7.62 - 63.5 mm/minute)	6, 7, 10, 12, or 18 in. (154.4, 177.8, 254, 304.8, or 457.2 mm)	Morse taper #4, #5 #40 NMTB adapters available	Up to 3.25 in. (82.6 mm) diameter	Hydraulic (10 HP)

MILLING MACHINES

Wherever equipment repair applications involve milling critical mounting surfaces, CLIMAX has a precision machine that can be perfectly configured to fit. Our portable three-axis **milling machine** family starts with the PM4200 – a versatile model with available bed options with 20, 49 or 78 inches (508, 1244.6 and 1981.2 mm) of travel. Our largest mill, the LM6200 features the ability to configure for linear AND gantry milling, with up to 176 inches (4470.4 mm) of x-axis travel and 106 inches (2692.4 mm) of y-axis travel. There is plenty of spindle torque for fast metal removal and the capacity to mill in nearly any position.

For about the same cost as machining a keyway off-site, you can purchase a CLIMAX **key mill**. These two-axis and three-axis mills cut keyways, slots, pockets, or flats on shaft diameters of 1.5 to 24 inches (38 to 610 mm). They can be operated in any position, thanks to their sealed gearbox lubrication.



PM4200 Milling Machine

The PM4200 features longitudinal power feed with cross travel controlled manually. Attachable to the workpiece or to a support structure. Choose X-axis travel up to 20, 49, or 78 inches (508.0, 1244.6, or 1981.2 mm).

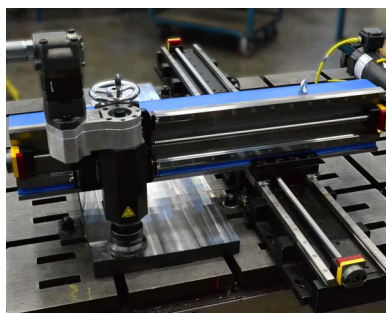

LM5200 Linear/Gantry Mill

Like nothing on the market today, the LM5200 for linear or gantry milling can be configured in almost any position! Modular or solid bed sections allow the length to be expanded from 48 to 96 inches (1219.2 to 2438.4 mm) without losing rigidity (with 36 to 84 inches [914.4 to 2133.6 mm] of travel). This portable mill offers maximum flexibility for operators that have diverse milling needs.



LM6200 Linear/Gantry Mill

This is CLIMAX's most powerful portable milling machine. A revolutionary, heavy-duty mill that can be configured for linear or gantry milling in nearly any position! Modular or solid bed sections allow the length to be expanded from 48 to 192 inches (1219.2 to 4876.8 mm) without losing rigidity (with 32 to 152 inches [812.8 to 4470.4 mm] of travel). Designed to handle demanding and difficult field machining conditions with features that ensure greater power, precision, and accuracy.

MILLING MACHINES

PROJECT SUCCESS

LM6200 LINEAR/GANTRY MILL | STEEL MILL

An East Coast USA steel mill asked one of our customers to look at machining a vertical wall in a harsh environment with limited access. Their machinists deployed two CLIMAX LM6200 milling machines coupled with fixtures they designed with technical support from CLIMAX. This equipment and technology allowed our customer to successfully complete the critical project ahead of schedule, reducing downtime for the client.



MILLING MACHINES

MILLING APPLICATIONS Milling of base plates for mounting pumps and motors • Milling of platens of large die casting presses • Machining of lock and dam gates • Milling of vertical slides on steel rolling mills • Shovel, excavator and dragline car body, track frame and side rail milling • Re-facing of mining truck struts • Heat exchanger seal slot milling

KEY MILL APPLICATIONS Milling of keyways in motor shafts • Milling of stress relief slots in bridges • Milling of radius slots in turbine shafts • Machining of pipe ID flats • Chipper and conveyer repair • Elevator shaft repair

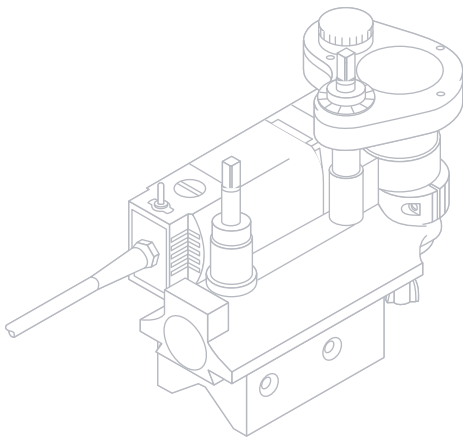

KEY MILLS

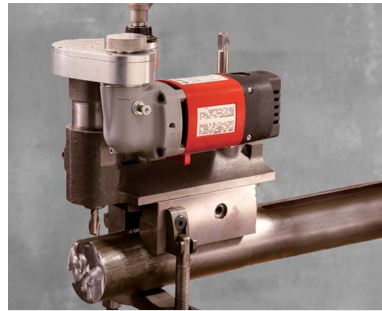

KM3000 Key Mill

The product that started CLIMAX more than 50 years ago! A small but rugged machine able to cut full-depth keyways or mill flats quickly, without requiring extensive dismantling or costly set-up time. Designed for shaft diameters from 0.75 to 10.5 inches (19.1 to 266.7 mm).

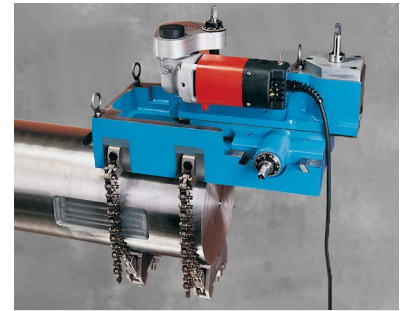

KM4000 Key Mill

A rugged performer designed with a 2 inch (50.8 mm) side-shift to cut wide keyways at minimal cost. Versatile, smooth and precise, it mounts anywhere along a shaft, at any angle, and eliminates the need for a costly assortment of different size cutters. For shaft diameters ranging from 4 to 24 inches (101.6 to 609.6 mm).

QUICK-TECH Milling Machine	X-AXIS TRAVEL	Y-AXIS TRAVEL	MAX. VERTICAL TRAVEL	SPINDLE SIZE	POWER
PM4200	20, 49, or 78 in. (508.0, 1244.6 or 1981.2 mm)	8 in. (203.2 mm) with weldon, 12 in. (304.8 mm) with HSK	3 in. (76.2 mm) with weldon spindle, 4 in. (101.6 mm) with HSK spindle	0.75 in. (19.1 mm) weldon, 40A (HSK)	Electric, pneumatic, or hydraulic
LM5200	36, 60, or 84 in. (914.4, 1524, or 2133.6 mm)	16 or 34 in. (406.4 or 863.6 mm)	4 in. (101.6 mm)	40 NMTB/CAT 40	Hydraulic
LM6200	32, 56, 80, 104, 128, 152, or 176 in. (812.8, 1422.4, 2032, 2641.6, 3251.2, 3860.8, or 4470.4 mm)	26, 38, 72, or 106 in. (660.4, 965.2, 1828.8, or 2692.4 mm)	8 in. (203.2 mm)	50 NMTB/CAT 50	Hydraulic
QUICK-TECH Key Mill	KEYWAY LENGTH	KEYWAY WIDTH	SHAFT DIAMETER	SPINDLE DIAMETER	POWER
KM3000	6 in. (152.4 mm)	1.25 in. (31.8 mm)	0.75 - 10.5 in. (19.1 - 266.7 mm)	0.625 in. (15.9 mm)	Electric, pneumatic, or hydraulic
KM4000	8 in. (203.2 mm)	3.25 in. with 2 in. sideshift (82.6 mm with 50.8 mm sideshift)	4 - 24 in (101.6 - 609.6 mm)	Inch: 0.75 in. (19 mm) Metric: 0.79 in. (20 mm)	Electric, pneumatic, or hydraulic

TUBE BEVELERS (BOILER GUN™)

The **BOILER GUN™** tube bevelers are a combination of power, versatility, and ease of use in a compact package. Designed to perform on-site machining on boiler tubes or other pipe applications with speed and accuracy, delivering the optimal speed and torque combination to make short work of your tube prep projects.



BG22 BOILER GUN™

With a working range of 0.5 - 2.5 inches (12.7 - 63.5 mm), the BG22 **BOILER GUN™** is easy to use with more power and versatility to get your jobs done faster. Field-proven and armed with the most power in the industry, the BG22 **BOILER GUN™** can bevel, square, and perform other machining operations on a wide range of tube and pipe sizes. Available in pneumatic, electric, and cordless electric to cover a wider range of applications more effectively.

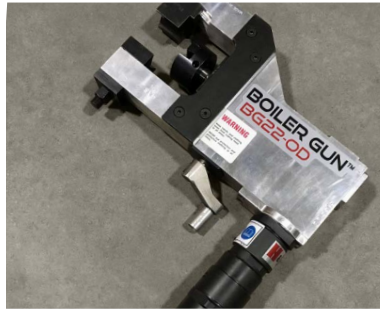

BG22 OD BOILER GUN™

The BG22 OD **BOILER GUN™** is a narrow-head tube machining tool for working in tight areas. The OD clamp system centers and locks the tool securely in place for excellent accuracy and safety. Mount a specialty cutting head and you can perform ID cleaning including the removal of tube rifling.



BG38 BOILER GUN™

The BG38 **BOILER GUN™** is a combination of ease of use, power, and versatility in a compact and lightweight package. Armed with unrivaled power, the BG38 can bevel, square, and perform other machining operations on a wide range of tubing. The BG38 has a working range of 0.625 inch ID to 3 inches OD (15.8 to 76.2 mm). Available in pneumatic, electric, and cordless electric to cover a wider range of applications more effectively.



BG38 SPECIAL BOILER GUN™

The BG38 SPECIAL **BOILER GUN™** is a high speed, high production tool that bevels, squares, and removes membranes on water wall panels. It is a powerful, lightweight machine that uses a patented pneumatic motor to turn the cutter with replaceable carbide inserts at 5,000 rpm to make short work of large projects.



BG44 BOILER GUN™

The BG44 **BOILER GUN™** is a combination of speed and power in a compact package, with a working range of 0.875 inch ID to 5 inches OD (22.2 to 127 mm). The BG44 is designed to perform on-site machining on boiler tubes and other pipe applications with speed and accuracy to make short work of your tube prep projects. Like other H&S TOOL **BOILER GUN™** tube bevelers, the BG44 offers a collet or wedge-styled locking system, giving users the best clamping capability for any application.



BG50 BOILER GUN™

The BG50 **BOILER GUN™** is the most powerful tube and pipe beveler in its class, with a working range of 1 inch ID to 5.562 inches OD (25.4 to 141.2 mm). Designed with a heavy duty gear set and tapered roller bearings, the BG50 offers users an extremely rigid and smooth operation, providing more torque and speed to perform a wide variety of end prep work. By adding a flange facing attachment, users can quickly turn the BG50 into a flange facer with automatic radial feed.

BOILER GUN™

TUBE BEVELERS (BOILER GUN™)

BOILER GUN™ APPLICATIONS Boiler tube repair • Stub removal • Pipe lines • Seal weld removal • Water wall repair • Hand hole cap removal • Fin-fan plug resurfacing • Fin removal • Attemperator plug removal • Heat exchanger weld repair • Tube condensers • Weld overlay machining • Dutchman/Single tube applications • Flange facing • Overlay removal • Overlay beveling • Counterboring (ID match and chill ring prep) • Membrane removal • Clad removal • Rifled tube boring • Tube sheet weld removal • J-Prep for orbital welding

MULTI-PREP®

One-step process that combines three applications

Our patented Multi-Prep® family of cutter heads can be mounted on any one of our BOILER GUN™ tube bevelers to perform a wide variety of machining applications simultaneously, such as OD bevel, fin removal, overlay removal, membrane removal, and clean tube OD. Using the H&S TOOL BOILER GUN™ tube bevelers with the patented Multi-Prep® tool head will increase the number of operations you can perform, saving you time and money.



QUICK-TECH Boiler Gun	WORKING RANGE	RADIAL TOOL CLEARANCE	HEAD WIDTH	POWER	SPEED
BG22	0.5 in. ID - 2.5 in. OD (12.7 ID - 63.5 OD mm)	0.8 in. (20.3 mm)	1.6 in. (50.8 mm)	Pneumatic (1.3 HP / 0.97 kW) Electric (1 HP / 0.75 kW) Cordless electric (5.2 amp/hr)	110 RPM 0 - 180 RPM 0 - 180 RPM
BG220D	0.75 in. ID - 2.25 in. OD (19.1 - 57.2 mm)	0.75 in. (19.1 mm)	1.5 in. (38.1 mm)	Pneumatic (1.3 HP / 0.97 kW)	160 RPM
BG38	0.625 in. ID - 3 in. OD (15.8 ID - 76.2 OD mm)	1.312 in. (33.3 mm)	2.625 in. (66.6 mm)	Pneumatic (1.3 HP / 0.97 kW) - Low-velocity (LV) - High-velocity (HV) - Extra high-velocity (Plus) Electric (1 HP / 0.75 kW) Cordless Electric (5.2 amp/hr)	90 RPM 140 RPM 200 RPM 0 - 270 RPM 0 - 105 RPM
BG38 SPECIAL	0.5 in. ID - 3 in. OD (12.7 - 76.2 mm)	0.750 in. (19 mm)	1.5 in. (38.1 mm)	Pneumatic (4 HP / 3 kW)	5,000 RPM
BG44	0.875 in. ID - 5 in. OD (22.2 ID - 127 OD mm)	1.312 in. (33.3 mm)	2.625 in. (66.7 mm)	Pneumatic (1.3 HP / 0.97 kW) - Low-velocity (LV) - High-velocity (HV) Electric (1.5 HP / 1.1 kW)	55 RPM 110 RPM 0 - 98 RPM
BG50	1 in. ID - 5.562 in. OD (25.4 - 141.3 mm)	2.75 in. (69.83 mm)	4 in. (101.6 mm)	Pneumatic (1.3 HP / 0.97 kW) - Low-velocity (LV) - High-velocity (HV) Electric (1.5 HP / 1.1 kW)	55 RPM 100 RPM 98 - 176 RPM

POWER BEVELER / TUBE ROLLING & EXPANDING EQUIPMENT

H&S TOOL offers four models of portable **pipe bevelers** for fabrication shop and on-site field use. Each model has a large working range with the power and accuracy to meet budget and schedule demands.

The **tube rolling & expanding equipment** is compact, powerful and reliable. The pneumatic powered rolling motors range from small 1,000 rpm models, for condenser tubes, up to larger units that produce 600 ft lbs (821.1 Nm) of torque, for high pressure boiler tubes.



PB6 POWER BEVELER

The PB6 **POWER BEVELER** is a combination of power, versatility, and reliability in a compact package. Designed to perform on-site machining with speed and accuracy. It delivers the optimal speed and torque combination to make short work of your pipe prep projects.



PB8 POWER BEVELER

The PB8 **POWER BEVELER** is designed for tough mid-sized pipe projects. Portable, powerful and reliable, the PB8 performs all of your on-site machining with speed and accuracy, increasing your efficiency and keeping you on schedule.

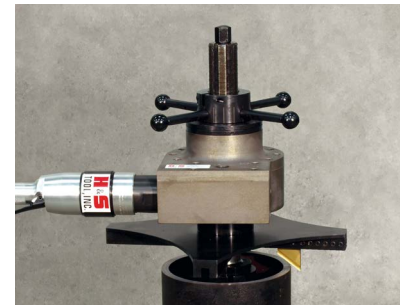

PB12 POWER BEVELER

The PB12 **POWER BEVELER** is designed to machine pipes from 3 to 14 inches (76.2 to 355.6 mm). The combination of power, versatility, and reliability allows the PB12 to perform on both standard and heavy wall materials.



PB30 POWER BEVELER

The PB30 **POWER BEVELER** is a powerful and reliable pipe machining and beveling tool. Heavy duty gearing combines with variable speed control for smooth, accurate cutting of different pipe sizes, wall thicknesses, and materials.

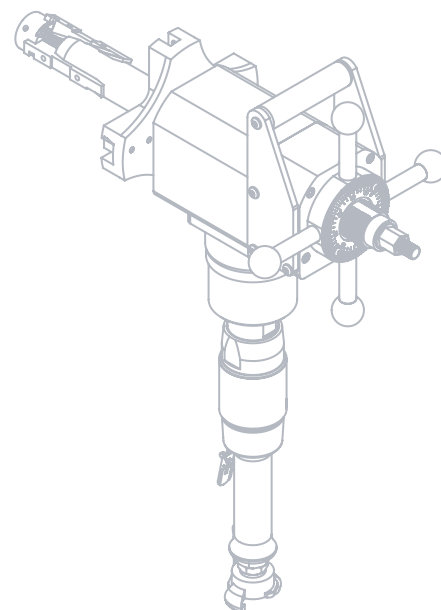

POWER BEVELER

POWER BEVELER / TUBE ROLLING & EXPANDING EQUIPMENT

POWER BEVELER APPLICATIONS Pipe line facing and beveling • Counter boring • Tube repair • Valve and fittings • Coupling repair • ID Bevels • Flange facing • Wall reduction • Counter boring • Drum and header beveling • Ship building

TUBE ROLLING & EXPANDING APPLICATIONS Fire tube boilers • Water tube boilers • Super heaters • Pressure vessels • Heat exchangers • Condensers • Chillers • Absorbers • Coolers • Evaporators

TUBE ROLLING & EXPANDING EQUIPMENT



TUBE ROLLING & EXPANDING EQUIPMENT

Compact, powerful, and reliable. Choose between small 1,000 rpm models for condenser tubes up to larger models that produce torque levels up to 600 ft lbs (821.1 N-m). All models have variable torque with sensing cam for accurate automatic expanding.

PROJECT SUCCESS

PB6 POWER BEVELER | PIPE CUTTING

An industrial service company needed to cut some extremely hard piping. The customer attempted to make the cuts using pipe bevelers from two different companies. After several broken bits and unsatisfactory performance, they rented the PB6 POWER BEVELER using H&S TOOL nitride tool bits. The customer made more cuts in one shift than the other pipe bevelers made in 3 days. They averaged 6 minutes per cut, making 40 cuts without changing the first set of bits, compared to the other pipe bevelers that averaged 20 minutes per pipe and required repeated changing out of the tool bits due to failure.

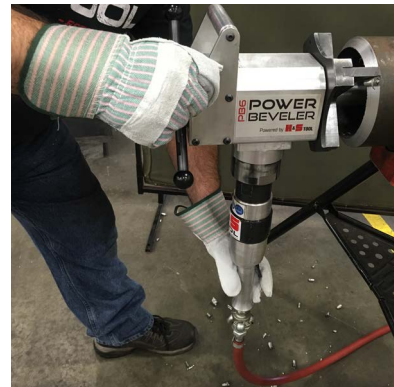

QUICK-TECH Power Beveler	WORKING RANGE	RADIAL TOOL CLEARANCE	TRAVEL	POWER	SPEED
PB6	1.7 in. ID - 7 in. OD (43.2 ID - 177.8 OD mm)	7 in. (177.8 mm)	3.0 in. (76.2 mm)	Pneumatic (3.0 HP / 2.2 kW), electric (2.5 HP / 1.9 kW), or hydraulic (4.9 HP / 3.4 kW)	0 - 40 RPM 0 - 52 RPM 0 - 40 RPM
PB8	2 in. ID - 8.625 in. OD (50.8 ID - 219.1 OD mm)	9 in. (228.6 mm)	3.5 in. (88.9 mm)	Pneumatic (3.0 HP / 2.2 kW), electric (2.5 HP / 1.9 kW), or hydraulic (5.36 HP / 4.0 kW)	0 - 22 RPM 0 - 37 RPM 0 - 40 RPM
PB12	3 in. ID - 14 in. OD (76.2 ID - 355.6 OD mm)	14 in. (355.6 mm)	4.5 in. (114.3 mm)	Pneumatic (3.0 HP / 2.2 kW), electric (2.5 HP / 1.9 kW), or hydraulic (5.36 HP / 4.0 kW)	0 - 18 RPM 0 - 32 RPM 0 - 40 RPM
PB30	8 in. ID - 30 in. OD (203.2 ID - 762.0 OD mm)	24 in. (609.6 mm) & 30 in. (762 mm)	4.5 in. (114.3 mm)	Pneumatic (3.5 HP / 2.6 kW) or hydraulic (10.72 HP / 8.0 kW)	0 - 3.5 RPM 0 - 12 RPM
QUICK-TECH Tube Rolling Equipment	WORKING RANGE	TORQUE LEVEL		POWER	
TUBE ROLLING & EXPANDING EQUIPMENT	0.25 in. ID - 4.5 in. OD (6.4 - 114.3 mm)	Up to 600 ft lbs (821.1 N-m)		Pneumatic	

SPLIT-FRAME OD MOUNT MACHINE / PIPE SAWS

The H&S TOOL **split-frame OD mount machine** (clamshell) design is a unique combination of safety, reliability, ease of use, rigidity, and precision. With three options to choose from the split-frame OD mount machine can cover a wider range of applications to meet the demands of your specific project.

The H&S TOOL **pipe saws** reliably cut tubes and pipes with speed and accuracy. Abrasive cutting wheel saws are offered in two hand-held models and one track-mounted model with optional cutting wheel sizes. The versatile chain-mounted reciprocating saw cuts up to 24 inches (609.6 mm).

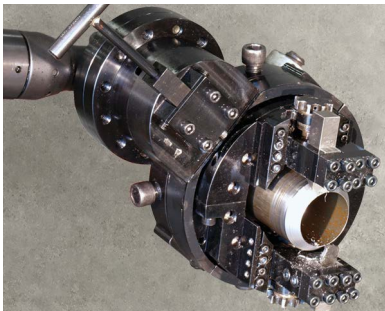

MFC Split-Frame Machine

The MFC small diameter series fits in tight places with a range from 0.625 to 2.625 inches OD (15.9 to 66.7 mm). The MFC design is a unique combination of accuracy, strength, and ease of handling for in-line pipe bevels and severs.

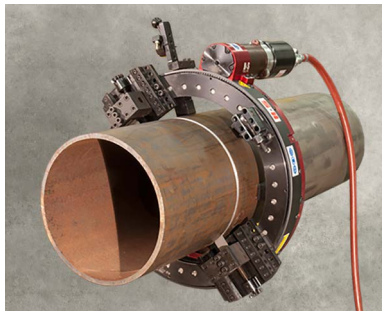

AFC Split-Frame Machine

The versatile AFC split-frame machines are portable pipe lathes designed to simultaneously sever and bevel pipe. The frame is split for easy installation on in-line pipes. With a range from 1 to 42 inches (25.4 to 1066.82 mm), the AFC series is very rigid with a light-weight aluminum body offering the highest strength-to-weight ratio on the market today. The patented remote tripper assembly allows users to sever and bevel remotely, keeping operators hands away from moving parts.



BFC Split-Frame Machine

The heavy-duty BFC series features a thicker body to withstand the high torque required for heavy wall pipes in large diameters ranging from 48 to 86 inches (1219.2 to 2184.4 mm). Stackable extension pads allow for greater flexibility and the 3/4 inch (19 mm) locator pad adjustment minimizes the number of extension pads to cover the working range. The patent protected pocket-style motor mount eliminates motor twisting and ring gear damage, increasing reliability and reducing total cost of ownership.

SPLIT-FRAME OD MOUNT MACHINE

PROJECT SUCCESS

SPLIT-FRAME OD MOUNT MACHINE | PIPE CUTTING

A customer needed to use a 12 inch (304.8 mm) split-frame OD mount machine (clamshell) to cut new pipe material, a hard brittle alloyed ash line pipe, used for a 10.5 inch (266.7 mm) OD diameter, with a 1 inch (25.4 mm) wall. The material was hard enough that if dropped, it could break. Using the H&S TOOL AFC-12 with H&S TOOL T15 blades, the customer not only completed the cuts successfully, but they were able to average forty cuts per set of blades.

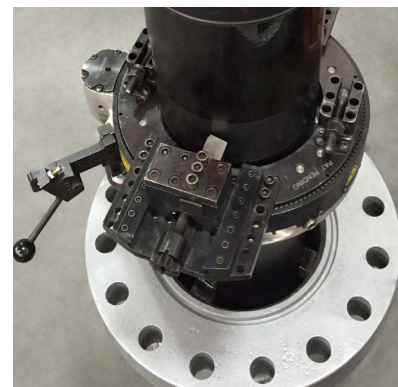

SPLIT-FRAME OD MOUNT MACHINE / PIPE SAWS

SPLIT-FRAME OD MOUNT APPLICATIONS Pipe severing, beveling, squaring • Flange re-surfacing • Desalination plant pipe severing & beveling • Counterbore machining • Food processing plant pipe severing & beveling • Airport fuel line piping repair • Industrial pipe replacement • OD Shaft turning • Weld cap removal • Cutting/Machining HDPE piping • Trepanning • Casing abandonments • Offshore caisson cutting • Pipe grooving • Pipeline distribution • Decommissioning • Valve replacement • Vessel machining • Municipality water lines

PIPE SAW APPLICATIONS Waterwall panel replacement • Single tube repair/replacement • Single pipe repair/replacement • Sawing: cutting casing and membrane

PIPE SAWS



RS24 Reciprocating Saw

The RS24 reciprocating saw is a versatile, reliable tool that can cut up to 24 inches (609.6 mm) in diameter. It can be used as a handheld saw or with optional pipe base, power feed, and bow accessories to make quick work of pipe or structural steel cutting applications.



CHS Compact Saw

The CHS is a compact, lightweight hand saw that produces high horsepower and over 5,000 RPM to cut through heavy wall pipes and tubes with ease. Proven in years of job-site use, these rugged saws have all of the features needed in a production tool.



TS-400 Track Saw

The model TS-400 is a powerful, accurate track saw that improves productivity in water wall panel replacement projects. The patented track mounting system eliminates wheels and rollers yet slides easily into position and stops kickbacks without the need for a lock.

QUICK-TECH Split-Frame	WORKING RANGE	SLIDE SWING	POWER
MFC	0.625 - 2.625 in. (15.9 - 66.7 mm)	1 in. (25.4 mm)	Pneumatic or electric
AFC	1 - 42 in. (25.4 - 1066.8 mm)	1, 2, 3, 4, 7, & 10 in. (25.4, 50.8, 76.2, 101.6, 177.8, & 254 mm)	Pneumatic, electric, or hydraulic
BFC	48 - 86 in. (1219.2 - 2184.4 mm)	1, 2, 3, 4, 7, & 10 in. (25.4, 50.8, 76.2, 101.6, 177.8, & 254 mm)	Pneumatic, electric, or hydraulic
QUICK-TECH Pipe Saw	CUT	TYPE OF SAW	POWER
RS24	Up to 24 in. (609.6 mm)	Reciprocating saw	Pneumatic
CHS	Depth of cut 2, 3, & 3.5 in. (50.8, 76.2, & 88.9 mm)	Track saw	Pneumatic
TS-400	Up to 4 in. (101.6 mm)	Hand saw	Pneumatic

VALVE REPAIR MACHINES

Lightweight for easy handling and installation, CLIMAX valve grinding and lapping machines span working ranges for gate valves from 1.3 to 39.4 inches (32 to 1000 mm) and Globe valves from 0.4 to 24 inches (10 to 600 mm) as well as conical seats. You can quickly change grinding disks and adjust the grind pressure during operation. Solid construction, sealed lubrication, and pre-loaded bearings ensure long life and low maintenance. From globe valves to control valves, CLIMAX **valve repair machines** pay for themselves by saving downtime, valve inventory costs, and off-site labor.



VM1000 Gate Valve Repair

Available in six configurations, able to grind and lap gate and check valve seats and resurface seat areas to original manufacturer specifications or better. A tilting adapter is included to assure quick and easy adjustment of grinding pressure.

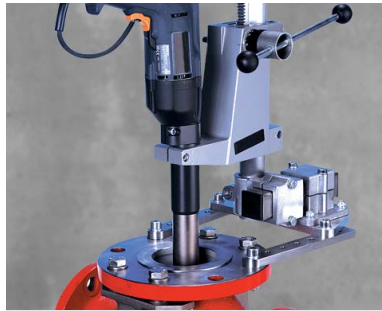

VM2000 Globe Valve Seat Grinding and Safety Valve Repair

A series of five rugged yet compact configurations designed for fast, precise grinding and lapping of globe valves with flat or conical seats. All models offer a range of diameter configurations and the ability to easily and quickly change disks and adjust grinding pressure during operation.



VM5800 Stationary Gate and Globe Valve Repair

This stand-alone stationary machine, suitable for service trucks as well as repair shops, offers a full range of grinding and lapping applications for globe and gate valves and gate valve wedges.



VM6000 Globe, Safety, and Control Valve Repair

Mount this directly on valves to do in-line valve throat repair, bore inside diameters, turn outside diameters, machine weld preps or apply weld build-up, undercut, or cut recesses and grooves. It machines inside diameters from 2.5 to 13 inches (63.5 to 330.2 mm).



VM7000 Safety Valve Repair

Designed specifically for mounting on Dresser Consolidated Maxi-Flow® valves, Crosby relief valves and others of similar configuration. The VM7000 allows you to bore, turn and face safety valve nozzles up to 6 inches (152.4 mm) in diameter.



VM8000 Globe and Control Valve Repair

Designed to bore, face, and thread Dresser Fisher and Dresser Masoneilan control valves or comparable configurations from 3 to 10 inches (76.2 to 254 mm) in diameter.

VALVE REPAIR MACHINES

APPLICATIONS Repairing and refurbishing of MSIV valves • Grinding and lapping of globe, check and gate valve seats • On-site re-machining of seat and seal areas on Fisher and Dresser control valves • In-place repair of safety valves

PROJECT SUCCESS

VM5800 | WEDGE GATE GRINDING

An industrial valve repair shop in Canada has found a new way of doing their wedge gate grinding using a CLIMAX VM5800. The grinding used to be accomplished by hand, with a plate and a drill; a typical job could take more than an hour to complete. With the VM5800 the operator can complete setup in about five minutes, then let it run. The owner of the shop commented "It's easy to set up and operate. A junior machinist can be trained to operate it in very short order."



QUICK-TECH Grinding & Lapping	SEAT DIAMETER RANGE	SUBMERGING DEPTH	VALVE TYPE	POWER
VM1150 & VM1200	1.25 - 8 in. (32 - 200 mm)	16 in. (400 mm)	Gate & swing check	Electric or pneumatic
VM1350, VM1500, & VM1600	1.5 - 24 in. (40 - 600 mm)	24, 31, or 39 in. (600, 800, or 1000 mm)	Gate & swing check	Electric or pneumatic
VM1700 & VM1900	8 - 39 in. (200 - 1000 mm)	39 or 55 in. (1000 or 1400 mm)	Gate & swing check	Electric or pneumatic
VM2050C, VM2100C, VM2150C, & VM2350	0.375 - 6 in. (10 - 150 mm)	10 or 18 in. (250 or 450 mm)	Globe (conical seats)	Electric or pneumatic
VM2050S & VM2150S	0.375 - 6 in. (10 - 150 mm)	12 in. (300 mm)	Globe (flat seats) & safety	Electric or pneumatic
VM2350, VM2500, & VM2600	3 - 24 in. (80 - 600 mm)	24 or 311 in. (600 or 800 mm)	Globe (flat seats)	Electric or pneumatic
VM5800	0.4 - 13.8 in. (10 - 350 mm)	N/A	Gate & globe	Electric
QUICK-TECH Single Point	VALVE NOZZLE DIAMETER	VALVE SEAT DIAMETER	VALVE THROAT DIAMETER	POWER
VM6000	N/A	2.5 - 13 in. (63.5 - 330.2 mm)	2.5 - 13 in. (63.5 - 330.2 mm)	Pneumatic
VM7000	1.5 - 6 in. (38.1 - 152.4 mm)	N/A	N/A	Pneumatic
VM8000	N/A	2.5 - 10 in. (63.5 - 254 mm)	3 - 10 in. (76.2 - 254 mm)	Pneumatic or hydraulic

CALDER VALVE TESTING EQUIPMENT

The lineup of CALDER advanced **valve testing systems**, manufactured by CLIMAX, are the most flexible and versatile systems on the market. The CALDER test system can seamlessly expand and evolve with your business, giving you the lowest total cost of ownership (TCO) and the highest return on investment (ROI) over the life of the tester. Our testing systems are designed, engineered, and manufactured to provide the most advanced equipment and accessories in the industry today. We specialize in Hydrostatic Valve Test Equipment and Pneumatic Valve Test Equipment. All CALDER products are available for sale worldwide, including the European Union and other locations where CE certification is required.

VALVE TESTING EQUIPMENT



HPC HYDROPRO™ Test Console

The HPC is the most versatile and user-friendly tester in the industry, capable of performing a wide variety of valve tests when paired with a CALDER hydraulic clamping system or even blind flanging. Every component in the tester is OEM-certified to the maximum allowable working pressure of the system. This is by far the most flexible and cost-effective way to manage your valve testing program.



USV HYDROPRO™ Universal Straight Valve Tester

Clamps and seals straight-bodied valves for pressure testing. Capable of hydrostatic tests up to 9,700 psi and low-pressure air tests up to 125 psi.* Our unique tilting feature rotates clamped valves 90° from horizontal to vertical, ensuring removal of all air prior to pressurizing the system. Our patented Easy-Out™ Seal Plate Holders allow quick change-out of seal plates from flanged to other valve end type connections without the use of special tools, bolts, nuts or gaskets.



UFV HYDROPRO™ Universal Flange Valve Tester

Clamps and seals flanged valves for pressure testing. Capable of hydrostatic tests up to 9,700 psi and low-pressure air tests up to 125 psi.* Our unique tilting feature rotates clamped valves 90° from horizontal to vertical, ensuring removal of all air prior to pressurizing the system. Paired with an HFS this is the best way to test API valves, where cross body pressure on the valve is not an option.



HFS HYDROPRO™ Hydraulic Flange Seals

Clamps and seals flanged valves for pressure testing and eliminates all those blind flanges. Paired with the HYDROPRO™ Universal Flange Valve Tester, it is capable of hydrostatic tests up to 9,700 psi and low pressure air tests up to 125 psi*, enabling the user to test API valves that have multiple flanges as well as valves that aren't straight, like elbow valves, 90's and T's.

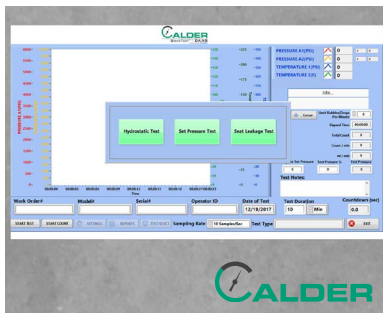

DAAS SMARTEST™
DACS SMARTEST PLUS™

The DAAS captures the performance of your valve test digitally and produces test reports and data files. The DACS automates the valve testing process for guaranteed repeatability. Built-in Wi-Fi capability allows for easy and secure sharing of data and automatic emailing of test reports and data files. The variable sample rate provides a high-density data stream which can be adjusted for short or long duration tests. This rugged splash-proof (IP67) unit is ideal for industrial valve testing environments.



TAT TURN-AROUND-TESTER™

Designed for easy transportation to job sites making it ideal for valve servicing companies or plant turnarounds, eliminating the need for taking valves back to the shop. The self-contained flanged valve testing system allows the operator to perform valve testing in a non-traditional environment. Capable of hydrostatic tests up to 9,700 psi and low-pressure air tests up to 125 psi.* Complete with clamp fixture and control console, the Turn-Around-Tester™ is a one-stop shop for valve testing on-site.

*9,700 psi (669 bar), 125 psi (9 bar)

CALDER VALVE TESTING EQUIPMENT

APPLICATIONS Gate Valve Testing • Globe Valve Testing • Check Valve Testing • Ball Valve Testing • Butterfly Valve Testing • Control Valve Testing • Safety Relief Valve Testing

VALVE TESTING EQUIPMENT





SRV Safety Relief Valve Tester

Performs SRV set pressure and seat leakage tests. Our unique 'J' tube design allows for a free flow of gas or water from the source to the SRV being tested providing a cushion of air under the SRV seat to prevent seat damage. The control panel is ergonomically designed 90° from the clamp fixture to provide a splash shield barrier between the operator and the clamp table.

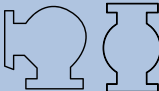

SRV | CONTROL VALVE COMBO TESTERS

The combination valve tester (CVT) family will support safety relief valves with flanges from 0.5 to 12 inches (12.7 to 304.8 mm) and control valves from 2 to 12 inches (50.8 - 304.8 mm). The patent-pending pressure-sensing safety interlock prevents releasing the valve while under test pressure. This universal platform will test gas valves up to 5,400 psi (372 bar) and hydrostatically test control valves up to 9,700 psi (669 bar). When paired with the HYDROPRO™ console and a SMARTEST™ system the operator will have the ability to support a wide range of applications throughout their facility.

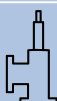
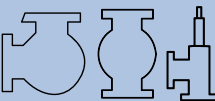
QUICK-TECH Valve Testing Equip.	TYPE OF VALVE	VALVE SHAPE	VALVE CLAMPING	TYPES OF TESTS
HPC	All except SRV's	Highly adaptable	Blind flange or any clamp fixture	Hydrostatic & low pressure air seat leakage
USV	Ball, globe, gate, check, & butterfly valves		Clamping across body	Hydrostatic & low pressure air seat leakage
UFV	Ball, globe, gate, & check valves		Flange clamping	Hydrostatic & low pressure air seat leakage
HFS	Ball, globe, gate, & check valves		Flange clamping	Hydrostatic & low pressure air seat leakage
TAT	Ball, globe, gate, & check valves		Flange clamping	Hydrostatic & low pressure air seat leakage
SRV	Relief valves		Flange clamping	Set/cracking point (water) & seat leakage (water, air, & nitrogen)
SRV CONTROL VALVE COMBO TESTERS	Ball, globe, gate, check, & relief valves		Flange clamping	Set/cracking point (water) & seat leakage (water, air, & nitrogen)
QUICK-TECH SMARTEST™	COMPUTER	PRESSURE RANGE		POWER REQUIREMENT
DAAS Data Acquisition and Analysis System	15.6 in. (1396.2 mm) panel PC with resistive touch screen and USB port front	3,000, 6,000, & 10,000 PSI (207, 414, & 689 bar) Other pressure ranges available upon request		Main power 120v or 230v single phase 50-60Hz
DACS Data Acquisition and Control System*	15.6 in. (1396.2 mm) panel PC with resistive touch screen and USB port front	3,000, 6,000, & 10,000 PSI (207, 414, & 689 bar) Other pressure ranges available upon request		Main power 120v or 230v single phase 50-60Hz

*Custom

With over 7,000 custom tools designed and manufactured, we're continuing to invent better ways to make our customers more efficient and competitive



CUSTOM ENGINEERING

Custom tool capabilities to meet the most complex challenge. Our designers and engineers are second-to-none in applying advanced machining insights to the modification of existing tools and accessories to meet special needs or customizing a completely unique solution to meet your "impossible" challenge head-on. Many of the patented innovations in today's CLIMAX, BORTECH, CALDER, and H&S TOOL lineup originated from one of our engineers inventing a better way to help a customer optimize their productivity, safety and results.

CNC AND PLC CAPABILITIES

The custom CLIMAX programmable machine controller capability is an industry leader in portable machining. From true Computer Numerical Controller (CNC) based g-code systems to simple conversational, field Programmable Logic Controller (PLC) operations, CLIMAX can develop a custom solution for your specific needs. CLIMAX has vast experience in developing custom machine control applications that enhance the customers' interface.



CUSTOM ENGINEERING

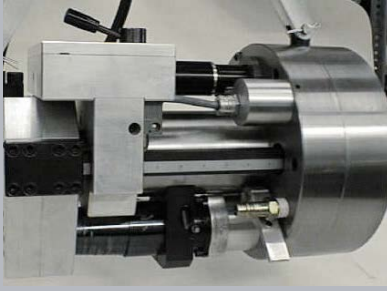

MIRROR BORING MACHINE

The Mirror Boring Machine is a precision machine tool that attaches to the front face of a turbine coupling with an electromagnetic chuck and precisely bores the bolt holes. To achieve proper centering and leveling of the boring machine, a fixture plate with holes matching the hole pattern of the coupling is machined flat within specifications. These holes allow the boring machine to quickly align itself. A centering pilot ring is attached to the machine's electromagnetic chuck. A specially designed lifting arm maintains the balance of the machine throughout its operational cycle.



TURBINE SPOT FACE GRINDING MACHINE

One machine with small and large machining range options covering a wide range of couplings. Precision mounting collets, fine grinding wheel adjustment and simplicity of machine design provides a versatile, quick to set up and highly accurate spot face grinding solution. Features include: Grind spot faces of bores in a full range of couplings, capable of alignment to the centerline of finished bores, mounts to and grinds counterbores of either assembled or separated couplings, and very precise counter bore axial run-out, counterbore flatness, perpendicularity of face to bore centerline and surface finish.



FINAL DRILLING OF HELICOPTER STORAGE RAILS

The customer was utilizing an older tape-driven drilling machine that was damaged in a hurricane. They requested that the machine be repaired and upgraded to include programmable logic control (PLC) to provide more efficient operation. Working with the existing machine base structure, CLIMAX re-conditioned the machine and added the requested programmable logic control functions. The resulting machine will provide enhanced operation and allow much faster and more precise drilling of the helicopter trolley storage rails.



LARGE-SCALE VERTICAL MILLING MACHINE

The customer was looking for a more efficient method to repair the lock doors, that would cause no significant delays in the flow of shipping to the cities downstream. CLIMAX designed, fabricated and fully tested two large-scale, custom-made vertical milling machines that could refurbish the lock doors and door quoins in place. These precise and powerful milling machines have a modular design, enabling each section to be assembled at the site then fastened to the doors. They are remotely operated to travel up and down the 70 foot (21.3 m) high walls in a single pass, removing up to 1.5 inches (38.1 mm) of material over multiple passes.



GANTRY VALVE TESTER

A variation from the standard Calder USV product line, the custom USVG-24-300T valve tester was engineered to optimize loading, unloading, and hydrostatic valve testing of large control valves. Capable of clamping and testing 4 to 24 inch (101.6 to 609.6 mm) valves with a maximum test pressure of 9,700 psi (668.8 bar), this massive machine uses an upper gantry assembly with heavy-duty rollers and hydraulic cylinders that enables the upper section to move forward and backward for valve loading and unloading onto the stationary platform seal plate. This versatility was ideal for the customer's facility as they used an overhead horizontal crane to position their valves flange-down for testing.



The most powerful CLIMAX tool, **Our People:** Ready to serve with innovative engineering, comprehensive training, and global customer support.

TUBE
PULLING

VALVE GRINDING &
LAPPING MACHINES

WELDING

LINE BORING MACHINES

MILLING

CIRCULAR

Pipe Cutting &
Beveling Machines

MACHINES

ADVANCED

DRILLS

MILLS

Valve Testing

ID MOUNT FLANGE FACING

BOILER
GUNS

POWER

LATHES

VALVE

BEVELERS

KEY MILLS

REPAIR

OD MOUNT FLANGE FACING

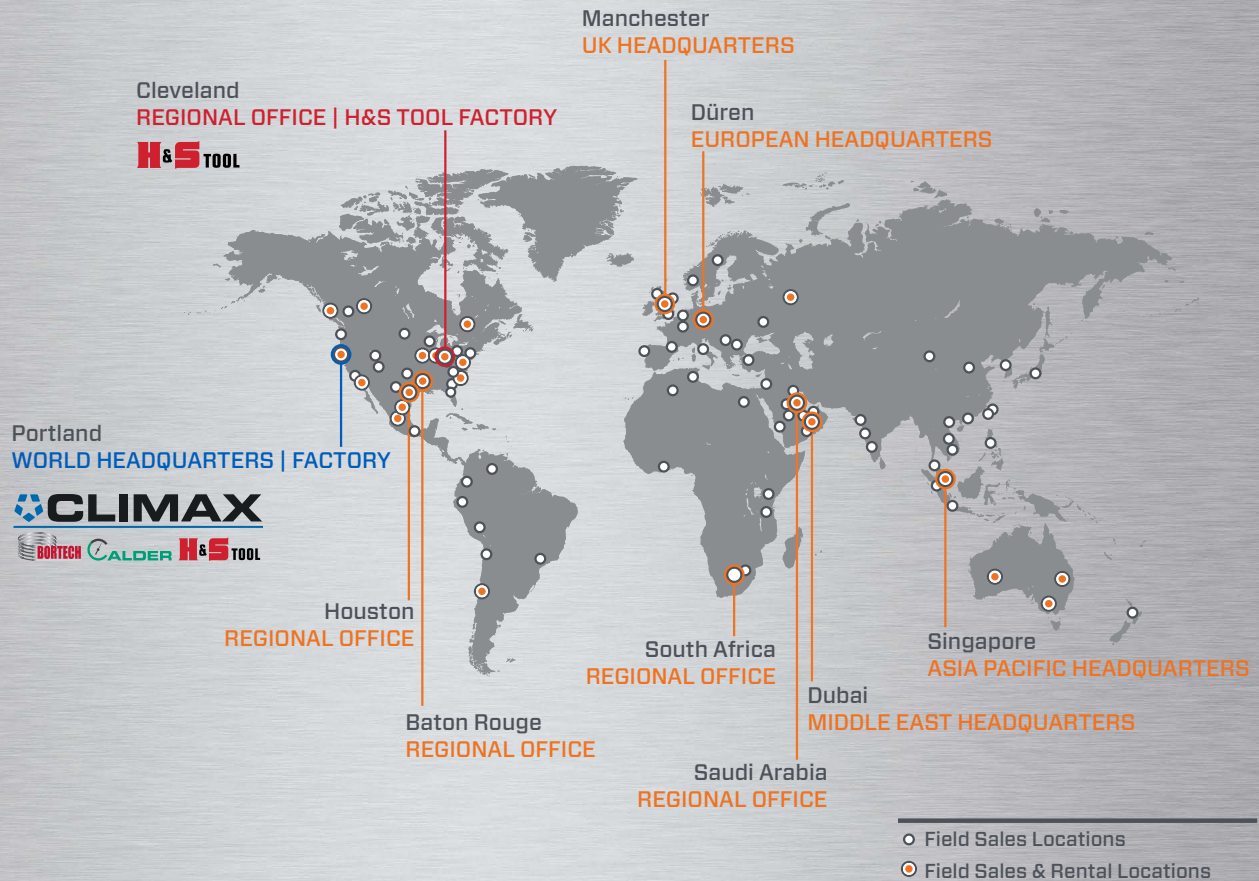

Visit our websites at climaxportable.com or hstool.com

FACTORIES

World Headquarters
CLIMAX | BORTECH | CALDER Factory
2712 E. Second Street
Newberg, OR 97132, USA
Telephone: +1.503.538.2185
Email: info@cpmt.com

Regional Office - Cleveland
H&S TOOL Factory
715 Weber Dr.
Wadsworth, OH 44281, USA
Telephone: +1.330.336.4550
Email: info@hstool.com

Asia Pacific Headquarters
308 Tanglin Road #02-01
Singapore 247974
Telephone: +65.6801.0662
Email: ClimaxAsia@cpmt.com

European Headquarters
Am Langen Graben 8
52353 Düren, Germany
Telephone: (+49) (0) 2421.9177.0
Email: ClimaxEurope@cpmt.com

Middle East Headquarters
Um Sequim Road
Al Quoz 4, Dubai, UAE
Telephone: +971.04.321.0328
Email: ClimaxUAE@cpmt.com

UK Headquarters
Unit 7 Castlehill, Bredbury Industrial
Park Bredbury, Stockport SK6 2SU, UK
Telephone: +44 (0) 161.406.1720
Email: ClimaxUK@cpmt.com

Regional Office - Louisiana
2816 S. Ruby St.
Gonzales, LA 70737, USA
Telephone: +1.985.974.6070
Email: info@cpmt.com

Regional Office - Texas
7003 Highway 225, #b
Deer Park, TX 77571-9704, USA
Telephone: +1.713.333.0260
Email: info@cpmt.com

Regional Office - South Africa
24 Phoenix Ave
Benoni, 1501 Gauteng
Johannesburg, South Africa
Telephone: +27 (11) 425.3850
Email: ClimaxUAE@cpmt.com

Regional Office - Saudi Arabia
Zamil Group Trade and services
P.O. Box 13793 | Dammam 31414
Saudi Arabia
Telephone: +966 (13) 892 4973
Email: ClimaxUAE@cpmt.com

