

Designed specifically for boring precise fitted bolt holes in large couplings and flanges.

Designed to bore precision coupling bolt holes on turbine and other coupling applications, this machine is optimized for boring fitted bolt holes in large couplings. Minimize shutdown time during turbine overhauls with features that allow quick setup and precision, round and straight bores.

Powerful, versatile and easy to use

- Quickly bores precisely aligned bolt holes the first time.
- Eliminates the need for lengthy honing procedures.
- Universal coupling mounting system adapts to all sizes of commercially available turbine couplings.
- Quick removal of the boring bar without disturbing setup. This allows measuring and inspection of the bore.
- Multiple feed options to suit your requirements.
- Reversing mechanical feed for limited space applications that allows back spot facing and counterboring.
- Electric feed allows reversing and also rapid tool return.
- Multiple drive options—hydraulic, pneumatic, or contact your sales representative for custom electric drive options.
- Switch easily between high speed steel or carbide tooling.

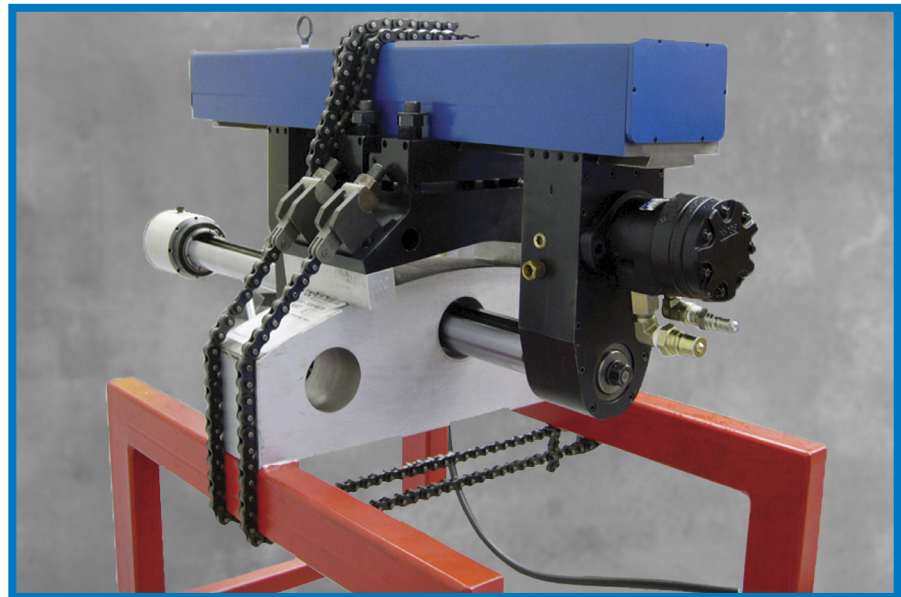

Compact Design

- Extremely rigid and very compact.
- Easily fits into confined spaces.
- Simple one operator setup.
- Minimum clearance Rotation Drive and Axial Feed only requires 2.0 inches (50.8 mm) clearance between the coupling hub OD and the bolt center.

SPECIFICATIONS

	US	Metric
BB5500 bar manufacturing tolerances are within 0.0005 inches (0.0127 mm) per 12 inch (304.8 mm)		
Boring Diameter	2.1 - 4.2 inches	53.3 - 106.7 mm
Coupling OD range:	27 - 60 inches	685.8 - 1524.0 mm
(The upper diameter is only limited by the amount of mounting chain. Please contact your Climax representative if you require larger diameter.)		
Axial feed rate:		
Mechanical feed	0 - 0.010 in/rev.	0 - 0.254 mm/rev.
Electric feed	0 - 3.5 inches/min.	0 - 88.9 mm/min.
Drive ratio	1.13:1 speed increase	1.13:1 speed increase
Torque produced at the boring bar (all with 5 Hp Hydraulic Power Unit)		
2.2 cubic inch Hydraulic Motor	19.5 ft-lbs	26.4 N•m
3.6 cubic inch Hydraulic Motor	35.4 ft-lbs	48.0 N•m
5.9 cubic inch Hydraulic Motor	57.5 ft-lbs	78.0 N•m
Perpendicularity and alignment dependent on operator set-up		
Mounting System		
Lateral fine adjustment	+/- 0.125 inches	+/- 3.175 mm
Radial fine adjustment	+/- 0.500 inches	+/- 12.7 mm
Typical Machine Ship Weight	700 lbs	318 kg
Shipping Dimensions (Machine shipped in 1 metal container)		
Machine W, D, H	30 x 60 x 37 inches	762 x 1524 x 940 mm
Bearing Spacing:		
Cutting should take place no further from a bearing than 5 times the bar diameter.		
Maximum recommended bearing spacing to achieve specs is as follows:		
<u>Bar Diameter</u>	<u>Max Bearing Spacing:</u>	
1-7/8 inch (47.6 mm)	19 inches (482.6 mm)	
2-1/2 inch (63.5 mm)	25 inches (635.0 mm)	
Max. Distance between RDU & bearing hanger:		
24 inch (609.6 mm) strongback:	18.4 inches (467.4 mm)	
36 inch (914.4 mm) strongback:	30.4 inches (772.2 mm)	
48 inch (1219.2 mm) strongback:	42.4 inches (1077.0 mm)	
The BB5500 mounts to OD of coupling. Due to length of RDU and bearing hanger, distance from coupling OD to bolt circle diameter is limited, and varies by coupling diameter.		
Bolt Circle Range Examples:		
Coupling OD	Min. bolt circle diameter	Max bolt circle diameter
27 inches (685.8 mm)	18.2 inches (462.3 mm)	22.9 inches (581.5 mm)
44 inches (1117.7 mm)	36.3 inches (922.0 mm)	40.9 inches (1038.9 mm)
60 inches (1524.0 mm)	52.9 inches (1343.7 mm)	57.5 inches (1460.5 mm)
To reduce minimum bolt circle diameter, order spacer blocks (see accessories, p.6)		

OPERATIONAL DIMENSIONS

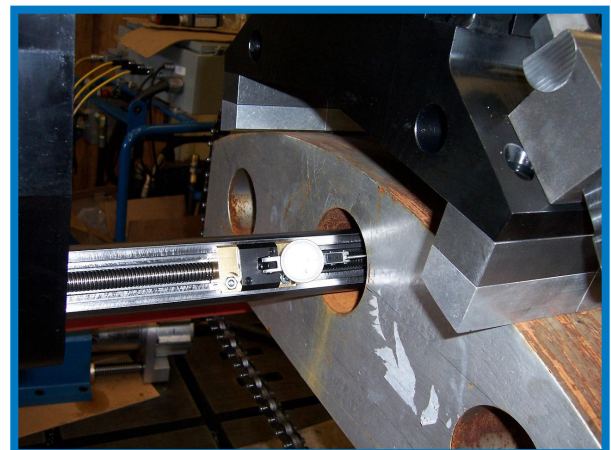
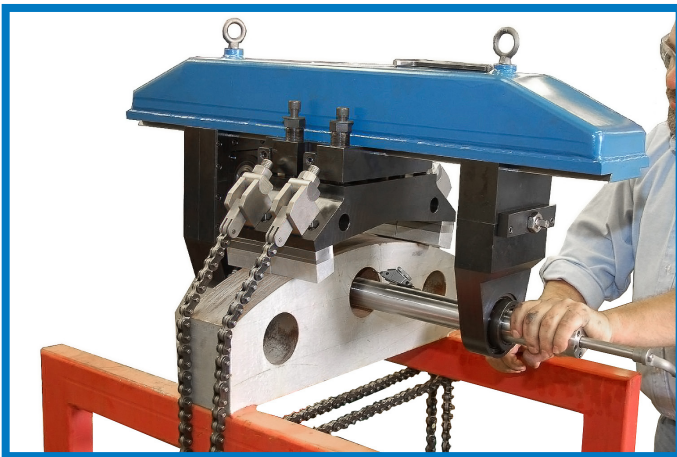
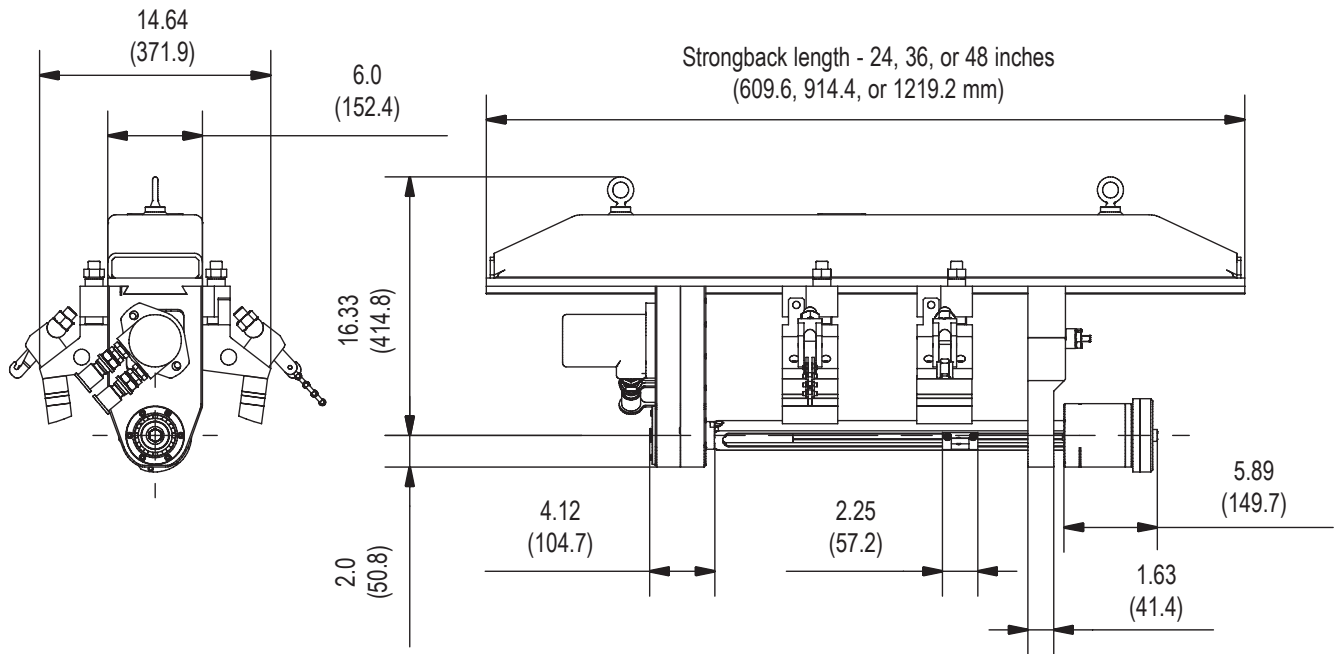

TOOL CONFIGURATIONS

Configure your BB5500 in 8 easy steps.

To configure your BB5500 Coupling Boring Machine:

- 1 Select a Base Unit
- 2 Select a Strong Back Assembly
- 3 Select a Lower Bar Hanger Bearing Assembly
- 4 Select a Boring Bar
- 5 Select a Tool Holder
- 6 Select a Tool Bit
- 7 Select a Feed System
- 8 Select a Drive Option

To configure the Coupling Boring Machine you require, simply select the option you need in each step, then contact your Climax representative.

1 Base Unit

(Includes the rotational drive unit (RDU), tool kit, mounting system, universal coupling mounting system, and instruction manual. The unit comes packed in a durable metal container.)
Base Model Package 47270

2 Strong Back Assembly

24 inch (609.6 mm) strong back assembly 46530
36 inch (914.4 mm) strong back assembly 46493
48 inch (1219.2 mm) strong back assembly 46486
* Multiple units may be ordered.

3 Lower Bar Hanger Bearing Assembly

For 1-7/8 inch (47.6 mm) diameter bar 27294
For 2-1/2 inch (63.5 mm) diameter bar 29043
* Multiple units may be ordered.

4 Boring Bar with Tool Slide

1-7/8 inch (47.6 mm) dia. 18 inches (457.2 mm) 47276
1-7/8 inch (47.6 mm) dia. 24 inches (609.6 mm) 47277
1-7/8 inch (47.6 mm) dia. 30 inches (762.0 mm) 47278
1-7/8 inch (47.6 mm) dia. 34 inches (863.6 mm) 47279
2-1/2 inch (63.5 mm) dia. 36 inches (914.4 mm) 47273
2-1/2 inch (63.5 mm) dia. 42 inches (1066.8 mm) 47274
2-1/2 inch (63.5 mm) dia. 48 inches (1219.2 mm) 47275
* Multiple units may be ordered.

5 Tool Holder

Tool insert holder, 5/16 inch square bit, small 46636
Tool insert holder, 5/16 inch square bit, medium 47189
#2 Microbore small tool holder 78531
#2 Microbore medium tool holder 78532
#3 Microbore small tool holder 78342
#3 Microbore medium tool holder 78343
#3 Microbore large tool holder 78344
All tool holders & tools, microbore & HSS kit 81374

6 Tool Bit

Tool bit HSS 5/16 x 1.25 LH 15 degree lead 46661
Tool bit HSS 5/16 x 0.78 LH 15 degree lead 50413
2 Metric microbore cartridge kit 78358
TCM-06 insert for #2 microbore 78420
#3 metric microbore cartridge kit 78359
TCM-09 insert for #3 microbore 78421

7 Feed System

Mechanical axial feed assembly (AFU)	26659
Mechanical axial feed assembly (AFU), reversible	47287
Electrical axial feed assembly with pendant	47294
Adapter sleeve for AFU, 1-7/8 - 2-1/2 inch (47.6 - 63.5 mm)	26444
Short adapter sleeve for AFU, 1-7/8 - 2-1/2 inch (47.6 - 63.5 mm)	55578

8 Drive System

2.2 cubic inch hydraulic motor assembly, keyed 1/2 FTG	39837
3.6 cubic inch hydraulic motor assembly, keyed 1/2 FTG	39843
5.9 cubic inch hydraulic motor assembly, keyed 1/2 FTG	39844
3.2 Hp (2.4 kW) 975 rpm pneumatic motor, CE-approved	28614
3 Hp (2.2 kW) 475 rpm pneumatic motor, CE-approved	28697

*Multiple units may be ordered.

Please contact your sales representative for custom electric motors.

Please select additional boring bars without tool slide from those shown below.

Special bar diameters and lengths also available. Please contact your Climax representative.

Part No.	Description
27285	2-1/2 inch (63.5 mm) diameter bar x 36 inches (914.4 mm) long
28765	2-1/2 inch (63.5 mm) diameter bar x 42 inches (1066.8 mm) long
44173	2-1/2 inch (63.5 mm) diameter bar x 48 inches (1219.2 mm) long
28177	1-7/8 inch (47.6 mm) diameter bar x 18 inches (457.2 mm) long
27286	1-7/8 inch (47.6 mm) diameter bar x 24 inches (609.6 mm) long
27287	1-7/8 inch (47.6 mm) diameter bar x 30 inches (762.0 mm) long
41089	1-7/8 inch (47.6 mm) diameter bar x 34 inches (863.6 mm) long

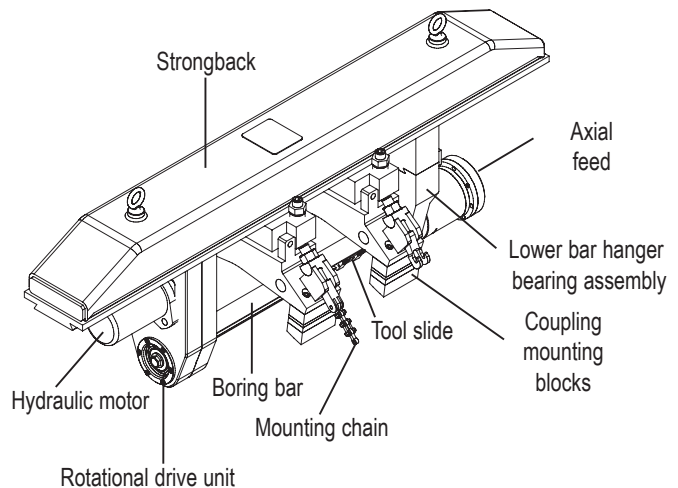

SETUP AND OPERATION

A Fast Six-Step Process

Setup of the BB5500 Coupling Boring Machine is quick and easy. An experienced operator can set up the machine in most typical coupling applications in about an hour (depending on alignment tolerances).

1 Remove the machine from the shipping container. Attach the correct spacers for the mounting feet based on coupling OD and BC dimensions. Make sure the base mounting adjustment bolts are centered.



Elapsed time: 10 minutes.

2 Position the strong back base supports, RDU and bearing hanger based on the coupling width. Lock the gib adjustments in place.

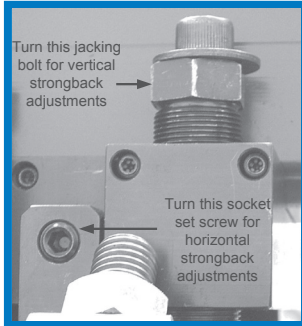

Elapsed time: 5 minutes.

3 Lift the machine onto the coupling OD. Roughly center the RDU spindle with the first bolt hole and secure by tightening the chain clamps.

Elapsed time: 10 minutes.

4 Install the boring bar. Tighten the bearing hanger clamp assembly.

Elapsed time: 5 minutes.



Block feet

5 Attach the drive motor to the RDU and the axial feed to the boring bar.

Elapsed time: 5 minutes.

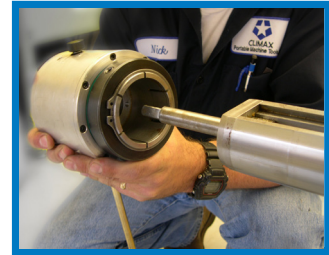

6 Dial indicate the bar to the hole by making fine lateral and radial adjustments on each base support. Install tooling and you are ready to start machining.

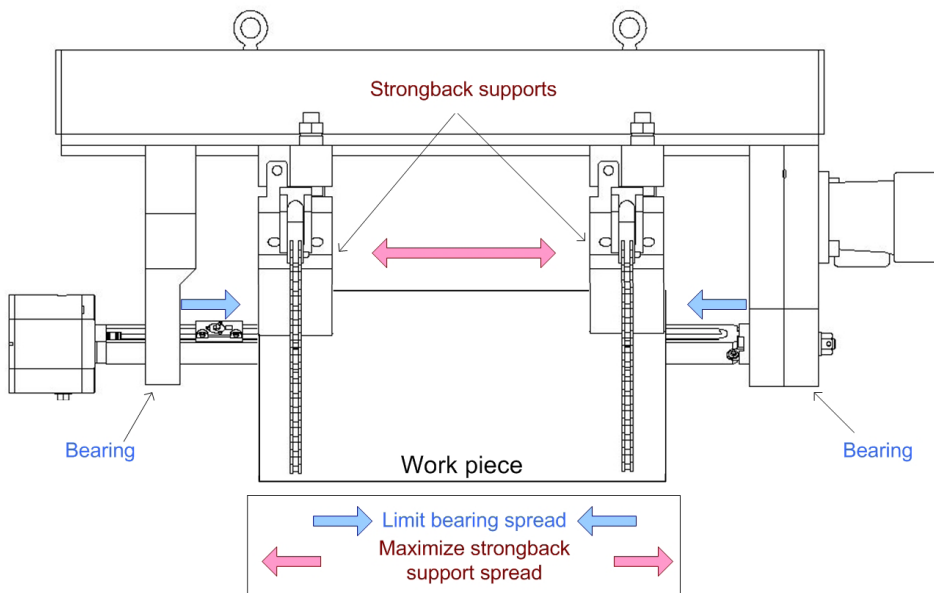

Elapsed time: 10 minutes.



Total elapsed time: approximately 45 minutes.

All subsequent bores on the same coupling require repeating only steps 3 thru 6.

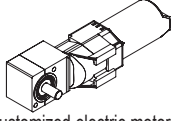
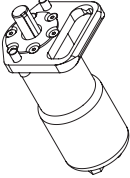
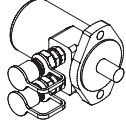
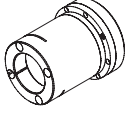
Performance is dependent on experienced operators, proper machine set-up, and correct bearing spacing.

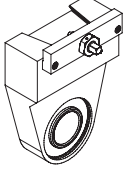
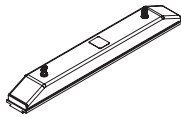
No.	Description	No.	Description																																																																														
	<p>Rotational Drive Unit (not shown) 46470 Features rigid steel housing with a #30MT spindle in adjustable preloaded sealed bearings. The drive motor is offset from the bar centerline for maximum clearance with a high performance toothed belt.</p>		<p>Boring Bars (not shown) Precision chromed with integral leadscrew. Available in a variety of diameters and lengths, with or without tool slide. Tool slides accept a variety of interchangeable tool holders for either HSS bits or micro adjustable indexable carbide inserts.</p> <table border="1"> <thead> <tr> <th>Part No.</th> <th>Bar Dia.</th> <th>Bar Length</th> <th>Tool Slide</th> </tr> </thead> <tbody> <tr><td>47276</td><td>1-7/8 (47.6)</td><td>18.0 (457.2)</td><td>Included</td></tr> <tr><td>47277</td><td>1-7/8 (47.6)</td><td>24.0 (609.6)</td><td>Included</td></tr> <tr><td>47278</td><td>1-7/8 (47.6)</td><td>30.0 (762.0)</td><td>Included</td></tr> <tr><td>47279</td><td>1-7/8 (47.6)</td><td>34.0 (863.6)</td><td>Included</td></tr> <tr><td>28177</td><td>1-7/8 (47.6)</td><td>18.0 (457.2)</td><td>Not included</td></tr> <tr><td>27286</td><td>1-7/8 (47.6)</td><td>24.0 (609.6)</td><td>Not included</td></tr> <tr><td>27287</td><td>1-7/8 (47.6)</td><td>30.0 (762.0)</td><td>Not included</td></tr> <tr><td>41089</td><td>1-7/8 (47.6)</td><td>34.0 (863.6)</td><td>Not included</td></tr> <tr><td>47273</td><td>2-1/2 (63.5)</td><td>36.0 (914.4)</td><td>Included</td></tr> <tr><td>47274</td><td>2-1/2 (63.5)</td><td>42.0 (1066.8)</td><td>Included</td></tr> <tr><td>47275</td><td>2-1/2 (63.5)</td><td>48.0 (1219.2)</td><td>Included</td></tr> <tr><td>27285</td><td>2-1/2 (63.5)</td><td>36.0 (914.4)</td><td>Not included</td></tr> <tr><td>28765</td><td>2-1/2 (63.5)</td><td>42.0 (1066.8)</td><td>Not included</td></tr> <tr><td>44173</td><td>2-1/2 (63.5)</td><td>48.0 (1219.2)</td><td>Not included</td></tr> <tr><td>47280</td><td>1-5/8 (41.3)</td><td>24.0 (609.6)</td><td>Included</td></tr> </tbody> </table>	Part No.	Bar Dia.	Bar Length	Tool Slide	47276	1-7/8 (47.6)	18.0 (457.2)	Included	47277	1-7/8 (47.6)	24.0 (609.6)	Included	47278	1-7/8 (47.6)	30.0 (762.0)	Included	47279	1-7/8 (47.6)	34.0 (863.6)	Included	28177	1-7/8 (47.6)	18.0 (457.2)	Not included	27286	1-7/8 (47.6)	24.0 (609.6)	Not included	27287	1-7/8 (47.6)	30.0 (762.0)	Not included	41089	1-7/8 (47.6)	34.0 (863.6)	Not included	47273	2-1/2 (63.5)	36.0 (914.4)	Included	47274	2-1/2 (63.5)	42.0 (1066.8)	Included	47275	2-1/2 (63.5)	48.0 (1219.2)	Included	27285	2-1/2 (63.5)	36.0 (914.4)	Not included	28765	2-1/2 (63.5)	42.0 (1066.8)	Not included	44173	2-1/2 (63.5)	48.0 (1219.2)	Not included	47280	1-5/8 (41.3)	24.0 (609.6)	Included														
Part No.	Bar Dia.	Bar Length	Tool Slide																																																																														
47276	1-7/8 (47.6)	18.0 (457.2)	Included																																																																														
47277	1-7/8 (47.6)	24.0 (609.6)	Included																																																																														
47278	1-7/8 (47.6)	30.0 (762.0)	Included																																																																														
47279	1-7/8 (47.6)	34.0 (863.6)	Included																																																																														
28177	1-7/8 (47.6)	18.0 (457.2)	Not included																																																																														
27286	1-7/8 (47.6)	24.0 (609.6)	Not included																																																																														
27287	1-7/8 (47.6)	30.0 (762.0)	Not included																																																																														
41089	1-7/8 (47.6)	34.0 (863.6)	Not included																																																																														
47273	2-1/2 (63.5)	36.0 (914.4)	Included																																																																														
47274	2-1/2 (63.5)	42.0 (1066.8)	Included																																																																														
47275	2-1/2 (63.5)	48.0 (1219.2)	Included																																																																														
27285	2-1/2 (63.5)	36.0 (914.4)	Not included																																																																														
28765	2-1/2 (63.5)	42.0 (1066.8)	Not included																																																																														
44173	2-1/2 (63.5)	48.0 (1219.2)	Not included																																																																														
47280	1-5/8 (41.3)	24.0 (609.6)	Included																																																																														
 Customized electric motor	<p>Motor Assemblies Please contact your sales representative for custom electric motors.</p> <p>28614 Pneumatic, 3 Hp (2.2 kW), 540 bar rpm @ 90 psi and 95 CFM (2.7 m³/min.) (Includes air conditioning unit)</p> <p>28697 Pneumatic, 3 Hp (2.2 kW), 250 bar rpm @ 90 psi and 95 CFM (2.7 m³/min.) (includes air conditioning unit)</p> <p>39837 Hydraulic, 2.2 in³ (36.0cm³), 550 bar rpm @ 5 GPM (18.9 L/min) with 1/2 inch (12.7 mm) fittings.</p> <p>39843 Hydraulic, 3.6 in³ (60.0cm³), 340 bar rpm @ 5 GPM (18.9 L/min) with 1/2 inch (12.7 mm) fittings.</p> <p>39844 Hydraulic, 5.9 in³ (96.7cm³), 210 bar rpm @ 5 GPM (18.9 L/min) with 1/2 inch (12.7 mm) fittings.</p>																																																																																
 Pneumatic motor assembly																																																																																	
 Hydraulic motor assembly																																																																																	
	<p>Axial Feed Unit Mechanical or electric options available for infinitely adjustable feed rates.</p> <p>26659 Mechanical, non-reversible</p> <p>47287 Mechanical, reversible</p> <p>47294 Electric, reversible, heavy-duty pendant</p>																																																																																
																																																																																	
	<p>Feed Box Adapter Sleeves</p> <p>26444 1-7/8 inch (47.6 mm) bar adapter</p> <p>42411 1-5/8 inch (47.6 mm) bar adapter</p>																																																																																
																																																																																	
	<p>Bearing Hanger</p> <p>29043 2-1/2 inch (63.5 mm) diameter straight hanger</p> <p>27294 1-7/8 inch (54.0 mm) diameter straight hanger</p> <p>42454 1-5/8 inch (47.6 mm) diameter straight hanger</p> <p>NOTE: Only one bearing hanger is required.</p>																																																																																
																																																																																	
	<p>Strongback</p> <p>46530 24.0 inch (609.6 mm) strongback</p> <p>46493 36.0 inch (914.4 mm) strongback</p> <p>46486 48.0 inch (1219.2 mm) strongback</p>																																																																																
																																																																																	
	<p>Spacer Blocks (to reduce min. bolt circle diameter)</p> <p>54496 2 inch (50.8 mm) spacer, for 4 inch (101.6 mm) diameter reduction</p> <p>54530 4 inch (101.6 mm) spacer, for 8 inch (203.2 mm) diameter reduction</p> <p>(Both spacers above may be stacked, for a total diameter reduction of 12 inches (304.8 mm).)</p>																																																																																
			<p>Tool Holders Select tool holder assembly from the table shown below.</p> <table border="1"> <thead> <tr> <th rowspan="2">PN</th> <th rowspan="2">Tool Type</th> <th colspan="2">1-7/8" Bar</th> <th colspan="2">2-1/2" Bar</th> </tr> <tr> <th>Min</th> <th>Max</th> <th>Min</th> <th>Max</th> </tr> </thead> <tbody> <tr> <td rowspan="2">46636</td> <td rowspan="2">5/16" sq HSS (PN 46661)</td> <td>2.087</td> <td>2.707</td> <td>2.520</td> <td>3.140</td> </tr> <tr> <td>(53.0)</td> <td>(68.8)</td> <td>(64.0)</td> <td>(79.8)</td> </tr> <tr> <td rowspan="2">47189</td> <td rowspan="2"></td> <td>2.660</td> <td>3.660</td> <td>2.756</td> <td>4.056</td> </tr> <tr> <td>(67.6)</td> <td>(93.0)</td> <td>(70.0)</td> <td>(103.0)</td> </tr> <tr> <td>78531</td> <td>No. 2 Microbore (PN 78358) Insert 78420</td> <td>2.090</td> <td>2.444</td> <td>NA</td> <td>NA</td> </tr> <tr> <td rowspan="2">78532</td> <td rowspan="2"></td> <td>2.435</td> <td>2.789</td> <td>2.515</td> <td>2.869</td> </tr> <tr> <td>(61.8)</td> <td>(70.8)</td> <td>(63.9)</td> <td>(72.9)</td> </tr> <tr> <td rowspan="2">78342</td> <td rowspan="2">No. 3 Microbore (PN 78359) Insert 78421</td> <td>2.650</td> <td>3.154</td> <td>2.730</td> <td>3.234</td> </tr> <tr> <td>(67.3)</td> <td>(80.1)</td> <td>(69.3)</td> <td>(82.1)</td> </tr> <tr> <td rowspan="2">78343</td> <td rowspan="2"></td> <td>3.145</td> <td>3.649</td> <td>3.225</td> <td>3.729</td> </tr> <tr> <td>(79.9)</td> <td>(92.7)</td> <td>(81.9)</td> <td>(94.7)</td> </tr> <tr> <td>78344</td> <td></td> <td>3.635</td> <td>4.139</td> <td>3.720</td> <td>4.224</td> </tr> <tr> <td></td> <td></td> <td>(92.3)</td> <td>(105.1)</td> <td>(94.5)</td> <td>(107.3)</td> </tr> </tbody> </table>	PN	Tool Type	1-7/8" Bar		2-1/2" Bar		Min	Max	Min	Max	46636	5/16" sq HSS (PN 46661)	2.087	2.707	2.520	3.140	(53.0)	(68.8)	(64.0)	(79.8)	47189		2.660	3.660	2.756	4.056	(67.6)	(93.0)	(70.0)	(103.0)	78531	No. 2 Microbore (PN 78358) Insert 78420	2.090	2.444	NA	NA	78532		2.435	2.789	2.515	2.869	(61.8)	(70.8)	(63.9)	(72.9)	78342	No. 3 Microbore (PN 78359) Insert 78421	2.650	3.154	2.730	3.234	(67.3)	(80.1)	(69.3)	(82.1)	78343		3.145	3.649	3.225	3.729	(79.9)	(92.7)	(81.9)	(94.7)	78344		3.635	4.139	3.720	4.224			(92.3)	(105.1)	(94.5)	(107.3)
PN	Tool Type	1-7/8" Bar				2-1/2" Bar																																																																											
		Min	Max	Min	Max																																																																												
46636	5/16" sq HSS (PN 46661)	2.087	2.707	2.520	3.140																																																																												
		(53.0)	(68.8)	(64.0)	(79.8)																																																																												
47189		2.660	3.660	2.756	4.056																																																																												
		(67.6)	(93.0)	(70.0)	(103.0)																																																																												
78531	No. 2 Microbore (PN 78358) Insert 78420	2.090	2.444	NA	NA																																																																												
78532		2.435	2.789	2.515	2.869																																																																												
		(61.8)	(70.8)	(63.9)	(72.9)																																																																												
78342	No. 3 Microbore (PN 78359) Insert 78421	2.650	3.154	2.730	3.234																																																																												
		(67.3)	(80.1)	(69.3)	(82.1)																																																																												
78343		3.145	3.649	3.225	3.729																																																																												
		(79.9)	(92.7)	(81.9)	(94.7)																																																																												
78344		3.635	4.139	3.720	4.224																																																																												
		(92.3)	(105.1)	(94.5)	(107.3)																																																																												
			<p>Tool Bits and Inserts</p> <p>27381 5/16 inch (7.9 mm) square carbide bits unground</p> <p>46661 Tool bit HSS 5/16 inch (7.9 mm) square 1.25 inch (31.8 mm) LH 15° lead</p> <p>78358 # 2 Metric microbore cartridge kit</p> <p>78420 TCM-06 insert for #2 microbore</p> <p>78359 #3 metric microbore cartridge kit</p> <p>78421 TCM-09 insert for #3 microbore</p> <p>46491 Tool Kit (included with base unit)</p> <p>29138 Dial Indicator</p> <p>47890 Dial Indicator Holder</p> <p>NOTE: Drawings are for reference only, are not to scale, and may not represent actual product.</p>																																																																														

CLIMAX Training Facilities

CLIMAX has been teaching the fundamentals and fine points of portable machine tool operation for practically as long as we've been inventing and building the tools.

We offer several training facilities across the United States - the Global Learning Center, situated in our corporate headquarters near Portland, Oregon, our Amherst, New Hampshire Training Facility, and our Houston, Texas Training Facility. All facilities offer training for machine tool operators on safety and machine setup and operation. Trainees also receive technical tips and tools to improve operational efficiencies, with the vast majority of every program devoted to hands-on activities and skill development.



The CLIMAX instructional team includes specialists in shipbuilding, power generation, civil engineering, bridge re-building, petrochemical and other industries.

Whether it's a regularly scheduled course at one of our training facilities, or custom curriculum conducted at your facility, your machinists will benefit from courses developed by some of the most respected authorities in the business.

Call us today to register for a regularly scheduled class, or talk to us about how we can customize a training program for your specialized application.



CLIMAX GLOBAL LOCATIONS

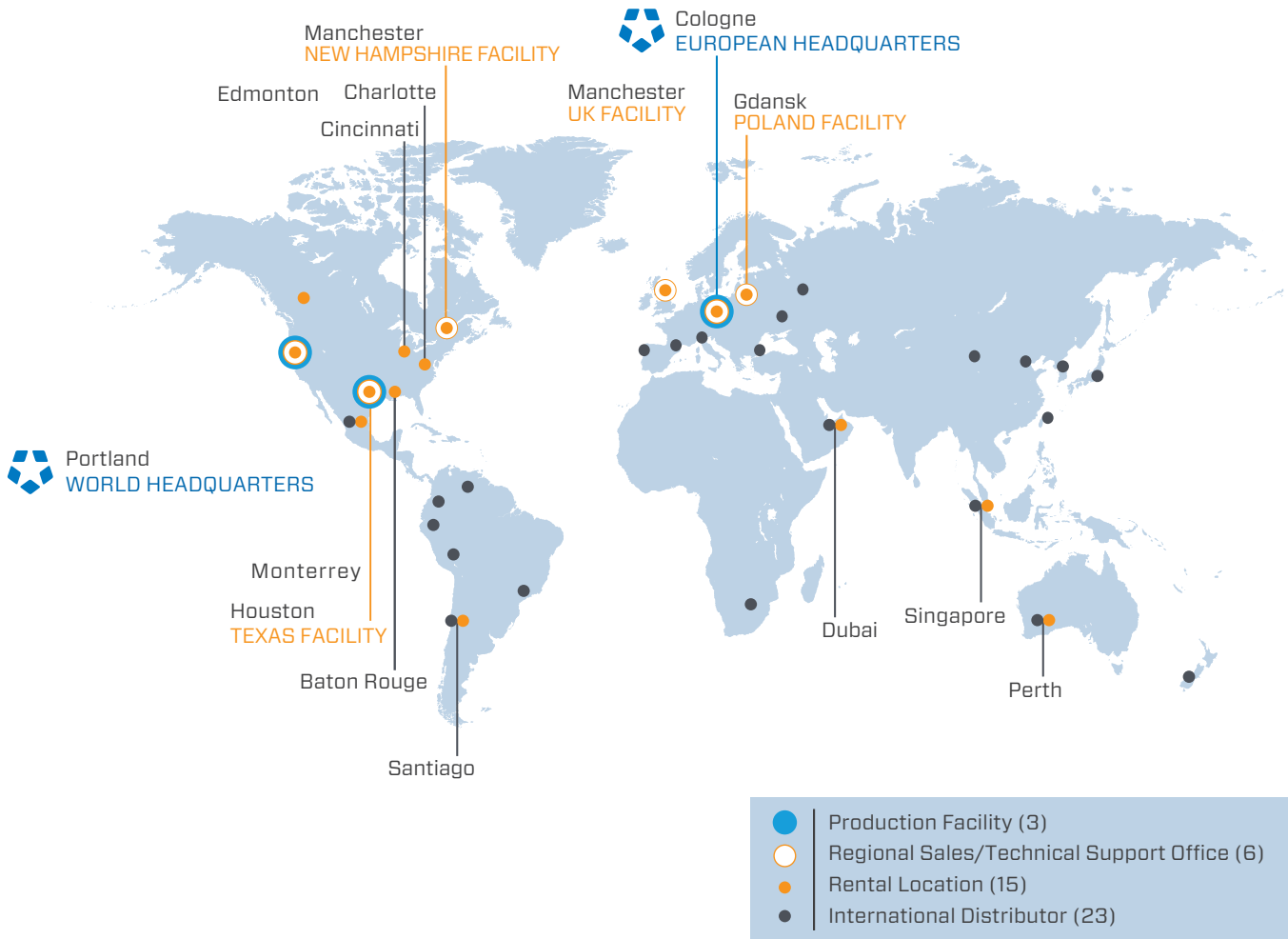

Call CLIMAX for:

Rentals

With 15 worldwide rental depot locations, you are never far away from a CLIMAX tool.

On-site Training

Need some refresher courses in setting up and operating your CLIMAX machine tool?

Special Projects

CLIMAX has been solving complicated machining, welding and valve testing problems for our customers since 1964.

Connect with us: [f](#) [t](#) [in](#) [g+](#)

World Headquarters

2712 E. Second Street
Newberg, Oregon 97132 USA
Worldwide Telephone: +1.503.538.2185
N. America Toll-Free: 1.800.333.8311
Fax: +1.503.538.7600
Email: info@cpmt.com

European Headquarters

Am Langen Graben 8
52353 Düren, Germany
Telephone: (+49) (0) 2421.9177.0
Fax: (+49) (0) 2421.9177.29
Email: info@cpmt.de

Copyright © 2015 CLIMAX Portable Machining & Welding Systems. All Rights Reserved. Climax has taken reasonable measures to ensure the accuracy of the information contained in this document. However, Climax makes no warranties or representations with respect to the information contained herein; and Climax shall not be held liable for damages resulting from any errors or omissions herein, or from the use of the information contained in this document.

 **CLIMAX**
Portable Machining & Welding Systems